

WARNING

- To avoid damaging the product, please release the gas from the magazines or cartridges while not operating.
- Sales and usage are restricted to 18-year-old people or older. Those below 18 years old are not allowed neither to purchase nor to operate alone.
- Never aim or shoot at people or animals. Please beware of childrens' mis-handling.
- Please read and fully understand all details listed in this instruction manual before using this air gun. You can download it from www.icsbb.com if you lose this instruction manual.

6mm BB



1 PART DESCRIPTION

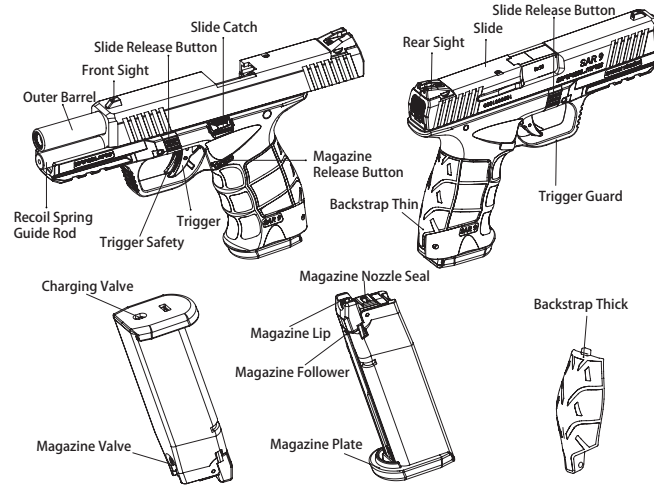

WARNING-ATTENTION



This model is featured with Gas-Blow-Back function, the slide will be pushed back and forth by the gas pressure strongly and rapidly while firing. To prevent injury, please keep your face and finger away from the slide.

The pistol could be damaged when using at temperature of 35°C (95°F) or above.

2 SAFETY DEVICE

If the Trigger Safety is not pressed properly, it will not fire normally.

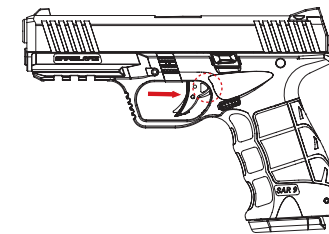

The Trigger Safety needs to be pressed properly to fire normally.

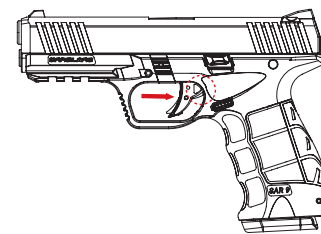

3 LOADING MAGAZINE

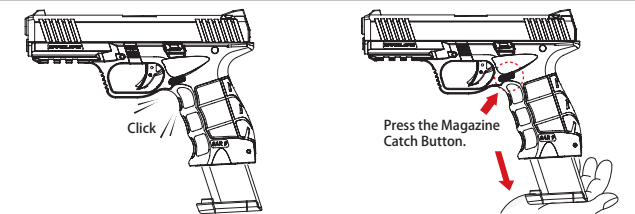

WARNING-ATTENTION

To prevent misfiring, keep your finger off the trigger and out of the trigger guard while loading the magazine. For safety reason, please remove the magazine while not operating.

Load the magazine until it clicks into the locking position. Do not insert the magazine by force. Release the magazine by pressing the Magazine Catch Button. Hold the magazine when releasing it from the pistol grip to prevent it from dropping.

4 CHARGING GAS

For the optimum product performance, please charge your magazine with 10-12kg airsoft use green gas. If you use green gas with non-recommended number of kg, it may cause damage or malfunction to the product.

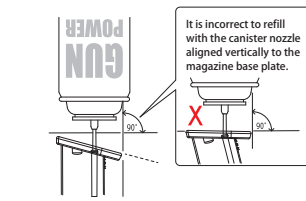

Please turn the magazine up side down to keep the injection hole side up, fill the gas only when the canister is verticalized to the injection hole. The gas will not be filled into the magazine or will leak out if the canister is not verticalized to the injection hole.

WARNING-ATTENTION

Please avoid to touch the injection hole. It might cause frostbite or low temperature burns if the skin is adhered by the gas.

To preserve the magazine Magazines are very delicate parts. Dropping them may cause damage or abnormality. Please avoid foreign matter remains on the Magazine Lip and injection hole on the magazine, which may cause abnormality. If refilling is necessary, please avoid to proceed when the magazine is loaded. Please unload the magazine before proceeding. Please do not place the magazines in wet or watery places, which may cause abnormality.

Precautions while filling:
 If you fill the magazine with a non-vertical way from up towards down, and caused the magazine is not completely filled, please deflate the gas completely, and refill the gas one more time as instructed.
 Fill the gas until the gas starts to leak out. When the gas is fully filled, gas inside the gas canister and magazine are balance without refilling anymore. It is the normal condition that the gas starts to leak out because it is not able to keep filling. Please stop filling immediately.
 Please use your magazine under normal temperature!
 If operating in environment of 20°C or below, the gas pressure will drop and might cause abnormal functions (The magazine will work normally again when temperature returns to normal temperature).
 If operating in environment of 35°C or above, the gas pressure will be too high and might cause abnormal functions (The magazine will work normally again when temperature returns to normal temperature).
 If you fill the magazine with gas and fire dozens of shots even under normal temperature, the gas pressure will also drop and cause the gas temperature to drop. Preparing several spare magazines for exchange is recommended.

5 LOADING BBs

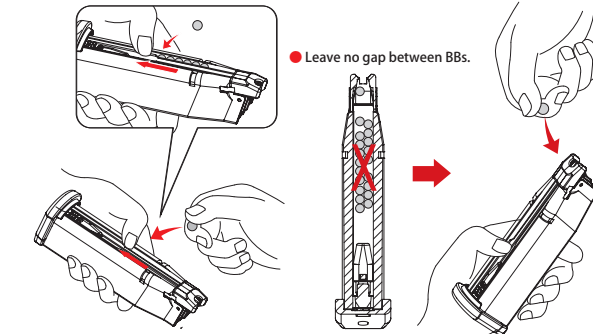

WARNING-ATTENTION

Do not release the Magazine Follower abruptly while pressing the follower. Releasing the follower carelessly may damage the Magazine Lip.

Pull the Magazine Follower down to the end, insert BBs into the BB slot. Maximum 22 rounds. You may insert the last BB through the Magazine Lip. Do not attempt to insert more than 22 BBs.

6 Loading

Insert the magazine. Pull the slide to the end and hold (the hammer will be down pressed). Release the slide (the slide is held at the back at the moment). Press the slide catch downward, the slide will be pushed forward (a BB pellet will be loaded into the barrel).

WARNING-ATTENTION

Keep your face and fingers away from the slide while the slide is operating. When the pistol is unloaded, the slide can be pushed forward when you pull and release it from the end. When the pistol is loaded, loading repeatedly will make the BBs load into the barrel repeatedly, which will lead to malfunction while firing and cause danger. When the hammer is pressed down, pulling the trigger will fire the BB. Please take extra notice.

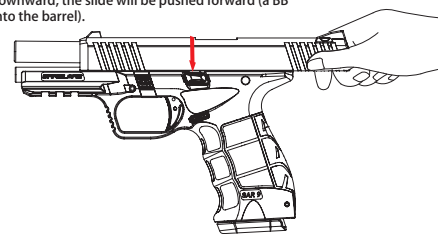

7 SHOOTING

Load the pistol according to Step 6. Pull the trigger to fire (a BB pellet will be fired and the slide will be pushed backward). The slide will be blown back and forth when firing.

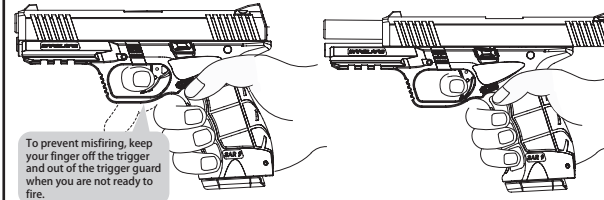

To prevent misfiring, keep your finger off the trigger and out of the trigger guard when you are not ready to fire.

When the BB is loaded into the barrel, the following process will be proceeded and repeat automatically everytime you pull the trigger: BB fired - Slide movement (blowed backward) - Load the next BB (Slide re-positioned)

WARNING-ATTENTION

Power Depression When the temperature inside the magazine is too low, the gas power will be depressed. The movement of the slide will be delayed. The slide Catch will not be bounced. The shooting range will not be far.

Shooting posture Please do not operate the pistol up side down for optimum performance.

ATTENTION
 The rails on the slide is very sharp. Please keep your face and fingers away from the slide while the slide is operating. Please keep your finger off the trigger and out of the Trigger Guard, and take extra caution to where the gun is aiming while proceeding non-firing operations.

8 STORAGE

Press the magazine catch button to release the magazine. Make sure the inner barrel is clear. If not, pull the slide backward, and turn the pistol up side down to remove the remaining BB, make sure no BBs are left inside the barrel (Push the BB pellet out from the barrel by the clearing rod is recommended). Press the slide catch lever to release the slide. Pull the trigger and fire several times towards safety directions, and make sure no BBs are left inside the barrel.

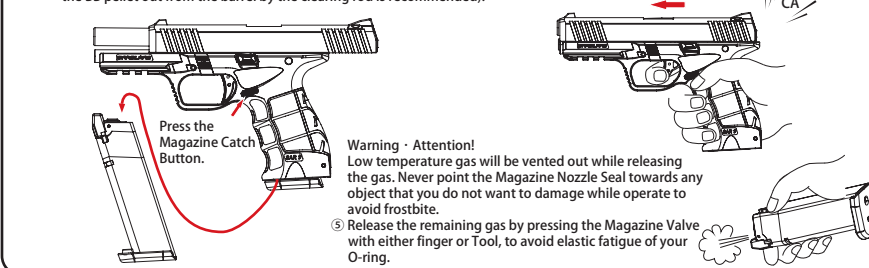

Warning - Attention! Low temperature gas will be vented out while releasing the gas. Never point the Magazine Nozzle Seal towards any object that you do not want to damage while operate to avoid frostbite. Release the remaining gas by pressing the Magazine Valve with either finger or Tool, to avoid elastic fatigue of your O-ring.

9 DISASSEMBLY (Do it when necessary)

Only disassemble your airsoft replica when adjusting the H-UP and proceeding to maintenance.

Press the Magazine Release Button to unload. Pull and hold the slide to the end. Press down and hold the slide Release Button.

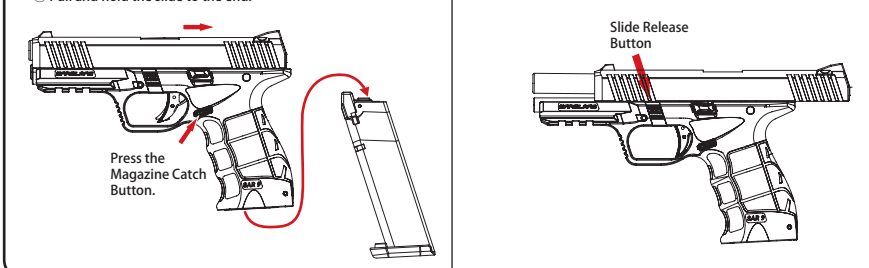

9 DISASSEMBLY (Do it when necessary)

④ Push the slide forward to remove.

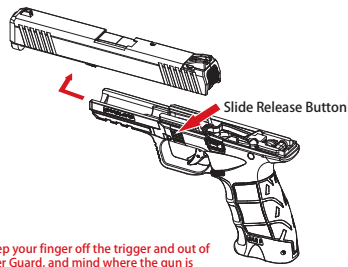

⑤ Push the Recoil Spring Guide forward and rise it to detach.
⑥ Push the Outer Barrel Assembly slightly forward, and rise it to remove.

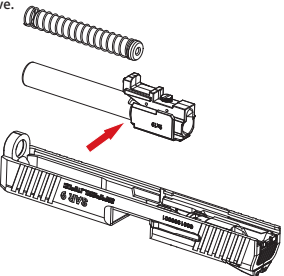

ATTENTION
△ Please keep your finger off the trigger and out of the Trigger Guard, and mind where the gun is aiming while proceeding non-firing operations.

10 H-UP ADJUSTMENT

① Please disassemble and remove the slide as step 9 instructed.
② Adjust the H-up dial with a screwdriver to adjust the height of the H-up.

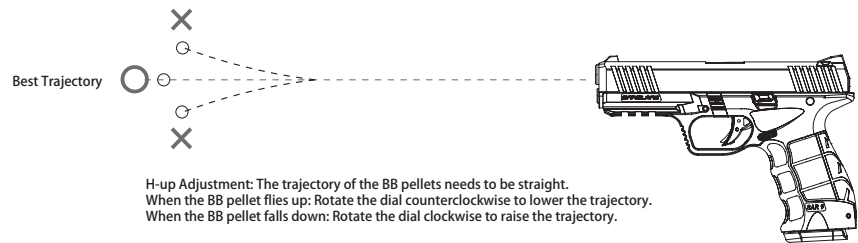
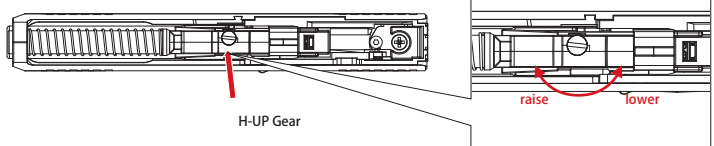

H-up Adjustment: The trajectory of the BB pellets needs to be straight.
When the BB pellet flies up: Rotate the dial counterclockwise to lower the trajectory.
When the BB pellet falls down: Rotate the dial clockwise to raise the trajectory.

11 ASSEMBLY

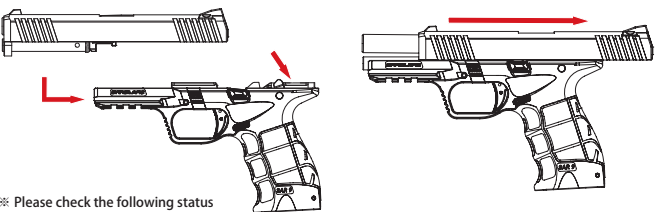

WARNING-ATTENTION

● ICS will not be responsible for any part assembling errors, missing parts, and problems such as malfunctions, accidents, injuries, caused by malfunction, and all the maintaining expenses will be beared by the customer themselves.

※ Please check the following status before assembly:
△ The Hammer must be down pressed.

① Insert the slide back to the receiver through the rail from the front.

② Push the slide to the end of the rail, then release it for repositioning.

12 Reversible Magazine Catch

The magazine catch can be reversed by proceeding as follows (Note: The pistol must be field stripped pursuant to the instructions in Step 9 before the magazine catch can be reversed).

① While pressing against both sides of the Magazine Catch to prevent it from moving, use a small flat head screwdriver to push the Magazine Catch Spring up and towards the slot shaped cut in the Magazine Catch to release the spring tension on the Magazine Catch. Use pliers to pull the Magazine Catch Spring upwards and out of the receiver.
② Remove the Magazine Catch and reinsert it in the frame from the outside.
③ Reverse the Magazine Catch and reinsert it in the other side of the frame from the outside.
④ Insert the Magazine Catch Spring with the pliers in the provided hole and push this down. Make sure to seat it completely. Using a small flat head screwdriver, push the end of the Magazine Catch Spring back into the slot shaped cut in the Magazine Catch.

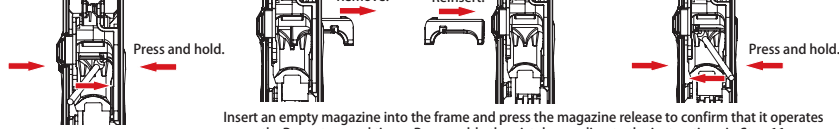

Insert an empty magazine into the frame and press the magazine release to confirm that it operates correctly. Repeat several times. Reassemble the pistol according to the instructions in Step 11.

13 BASIC TROUBLESHOOTING GUIDE

SYMPTOMS	POSSIBLE CAUSES	SOLUTIONS
No Response	Trigger has not been pulled firmly.	Pull the Trigger firmly.
	Magazine overpressured.	Press the valve gently to release gas and to adjust pressure. Be careful when gas is discharged from the Nozzle Seal.
	Insufficient gas inside the magazine.	Charge gas into magazine (refer to Step 4).
the slide blows back but no BB is fired	BB can't be loaded into the barrel.	Load the first BB into the barrel (refer to Step 6).
	BB is jammed inside the magazine.	Push out the BB by using the clearing rod, or pulling the slide backward, and turn the pistol up side down to remove.
Will not complete cycle	Magazine is too cold.	Use the magazine after it is returned to normal temperature (refer to Step 4).
	Magazine is too cold.	
	No gas in the magazine.	Charge gas into magazine (refer to Step 4).
Slide jammed	Lubricant or silicon oil is not enough.	Apply lubricant to the moving parts.
	BBs or foreign matters jammed inside the slide or frame.	Remove the BBs or foreign matters.
Gas comes out from the barrel	Slide Catch is not switched back to locking position.	Press the slide Catch downward to release the slide.
	Temperature is too low.	Use the magazine after it is returned to normal temperature (refer to Step 4).
Magazine is too cold.		
BBs fly up	H-UP is over adjusted.	Rotate the dial counterclockwise to lower the trajectory (refer to Step 10).
Shooting range is too short	H-UP isn't adjusted enough.	Rotate the dial clockwise to raise the trajectory (refer to Step 10).
	Foreign matters or oil in the inner barrel.	Clean the inner barrel and H-UP bucking.
BBs roll out of barrel	H-UP isn't adjusted enough.	Rotate the dial clockwise to raise the trajectory (refer to Step 10).
	H-UP is over adjusted.	Rotate the dial counterclockwise to lower the trajectory. (refer to step 10)
Jammed	Bad BBs, oversize BBs	0.2 g to 0.25 g 6 mm caliber BBs are recommended for optimum performance.
	Foreign matters or oil in the inner barrel.	Clean the inner barrel.

14 PARTS DIAGRAM

*The components/accessories for each model may have kind of differences depending on the actual goods. Images are only for reference.

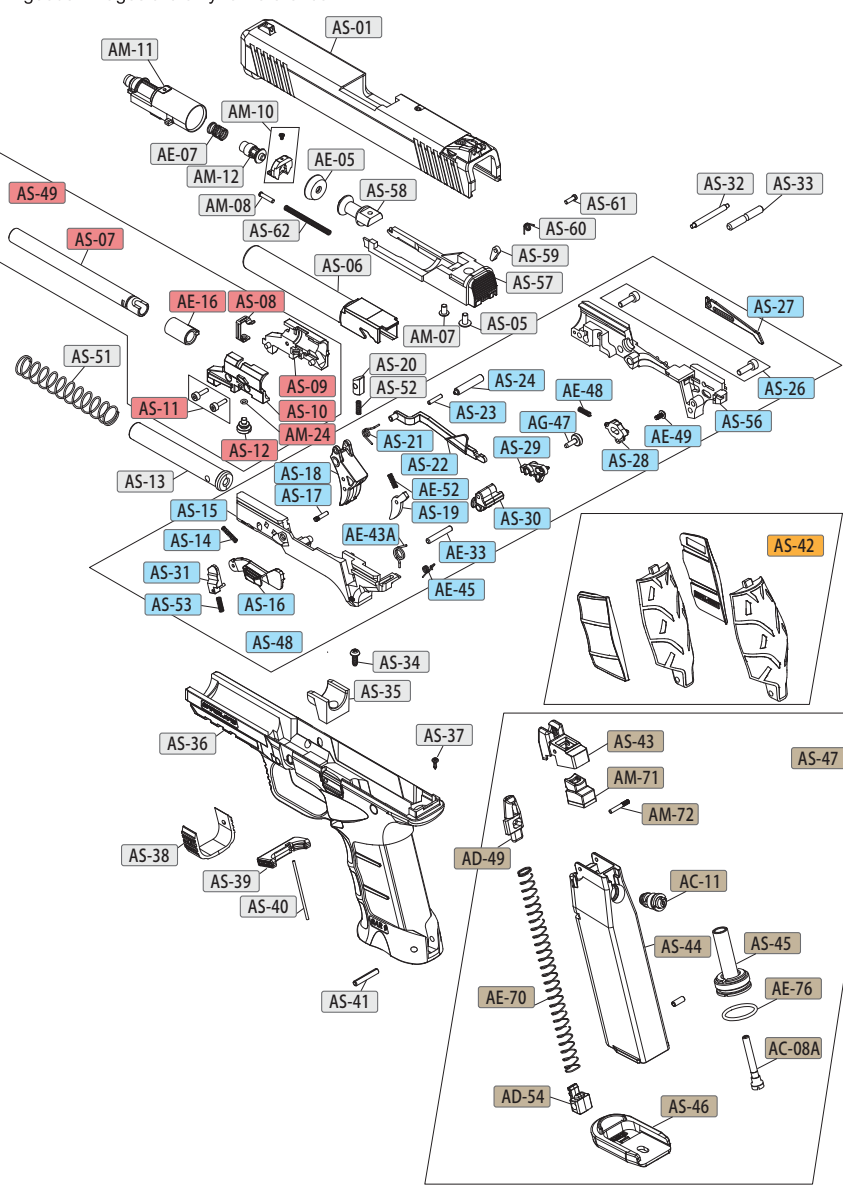

15 PARTS DESCRIPTION

ITEM#	DESCRIPTION	Q'TY	ITEM#	DESCRIPTION	Q'TY
AS-01	SAR 9 Slide Combination	1	AS-60	SAR 9.II Push Bar Spring (20pcs)	1
AS-05	SAR 9 Cylinder Housing Screw	1	AS-61	SAR 9.II Push Bar Pin (10pcs)	1
AS-06	SAR 9 Outer Barrel	1	AS-62	SAR 9.II Cylinder Housing Spring (10pcs)	1
AS-07	Inner Barrel (97 mm)	1	AC-08A	Revo Quantitative Gas Injection Valve	1
AS-08	SAR 9 H-UP Plate	1	AC-11	Revo.II Efficient Gas Release Valve	1
AS-09	SAR 9 H-UP Chamber-Right	1	AD-49	SAR 9 H-UP Combination	1
AS-10	SAR 9 H-UP Chamber-Left	1	AD-54	XPD Magazine Base Plate Stop	1
AS-11	SAR 9 H-UP Chamber Screw	2	AE-05	XAE Valve Plate	1
AS-12	SAR 9 H-UP Dial	1	AE-07	XAE Valve Spring	1
AS-13	SAR 9 Recoil Spring Guide	1	AE-16	H-UP Bucking	1
AS-14	SAR 9 Slide Catch Lever Spring	1	AE-33	Slide Catch Lever Plate Pin	1
AS-15	SAR 9 Trigger & Hammer Housing-Left	1	AE-43A	XAE Hammer Spring Asia Ver.	1
AS-16	SAR 9 Slide Catch Lever	1	AE-45	XAE Hammer Bar Spring	1
AS-17	Trigger Safety Pin	1	AE-48	XAE Hammer Disconnect Spring	1
AS-18	SAR 9 Trigger	1	AE-49	Round Head Hammer Housing Screw	1
AS-19	SAR 9 Trigger Safety	1	AE-52	XAE Hammer Disconnect Pin Spring	1
AS-20	SAR 9 Slide Positioning Block	1	AE-70	XAE Magazine Follower Spring	1
AS-21	SAR 9 Trigger Spring	1	AE-72	Magazine Base Plate Stop Pin	1
AS-22	SAR 9 Trigger Bar Lever	1	AE-76	O-ring	1
AS-23	Trigger Bar Spring Pin	1	AG-47	XFG Hammer Guide Wheel (10pcs)	1
AS-24	Trigger Bar Pin	1	AM-07	Cylinder Housing Screw	1
AS-26	Trigger & Hammer Combination Screw	2	AM-08	BM9 Hammer Housing Spring Pin (20pcs)	1
AS-27	SAR 9 Loaded Chamber Indicator Bar	1	AM-10	BM9 Valve Cover with Screw	1
AS-28	SAR 9 Sear	1	AM-11	BM9 Cylinder	1
AS-29	SAR 9 Hammer Bar	1	AM-12	BM9 Valve	1
AS-30	SAR 9 Hammer	1	AM-24	O-Ring	1
AS-31	SAR 9 Hammer Disconnect	1	AM-71	BM9 Magazine Nozzle Seal	1
AS-32	Slide Stop Bar Pin	1	AM-72	Magazine Lip Pin	1
AS-33	Slide Positioning Block Pin	1			
AS-34	Slide Positioning Block Screw	1			
AS-35	SAR 9 Slide Positioning Block	1			
AS-36	SAR 9 Frame-BK	1			
AS-37	Hammer Combination Screw	1			
AS-38	SAR 9 Slide Stop Bar	1			
AS-39	SAR 9 Magazine Catch Button	1			
AS-40	SAR 9 Magazine Catch Button Spring	1			
AS-41	SAR 9 Grip Plate Pin	1			
AS-42	SAR 9 Grip Plate	1			
AS-43	SAR 9 Magazine Lip	1			
AS-44	SAR 9 Magazine Case	1			
AS-45	SAR 9 Magazine Base	1			
AS-46	BM9 Magazine Plate	1			
AS-47	SAR 9 Magazine	1			
AS-48	SAR 9 Trigger & Hammer Combination	1			
AS-49	SAR 9 H-UP Combination	1			
AS-51	Recoil Spring	1			
AS-52	Slide Positioning Block Spring (10pcs)	1			
AS-53	Hammer Disconnect Pin Spring	1			
AS-56	SAR 9.II Trigger & Hammer Housing-Right	1			
AS-57	SAR 9.II Cylinder Housing	1			
AS-58	SAR 9.II Cylinder Cover Housing	1			
AS-59	SAR 9.II Push Bar (10pcs)	1			