

8 各部零件說明 Description

ICS-445S3

Lightway-Peleador.III S3 ERGO Stock

*紅色的零件號碼為SSS版本用件
The part numbers in red are for SSS.III version.

*每一款槍型基本配備不同依實際出貨為主。圖片僅供參考。
The components/accessories for each model may have kind of differences depending on the actual goods. Images are only for reference.

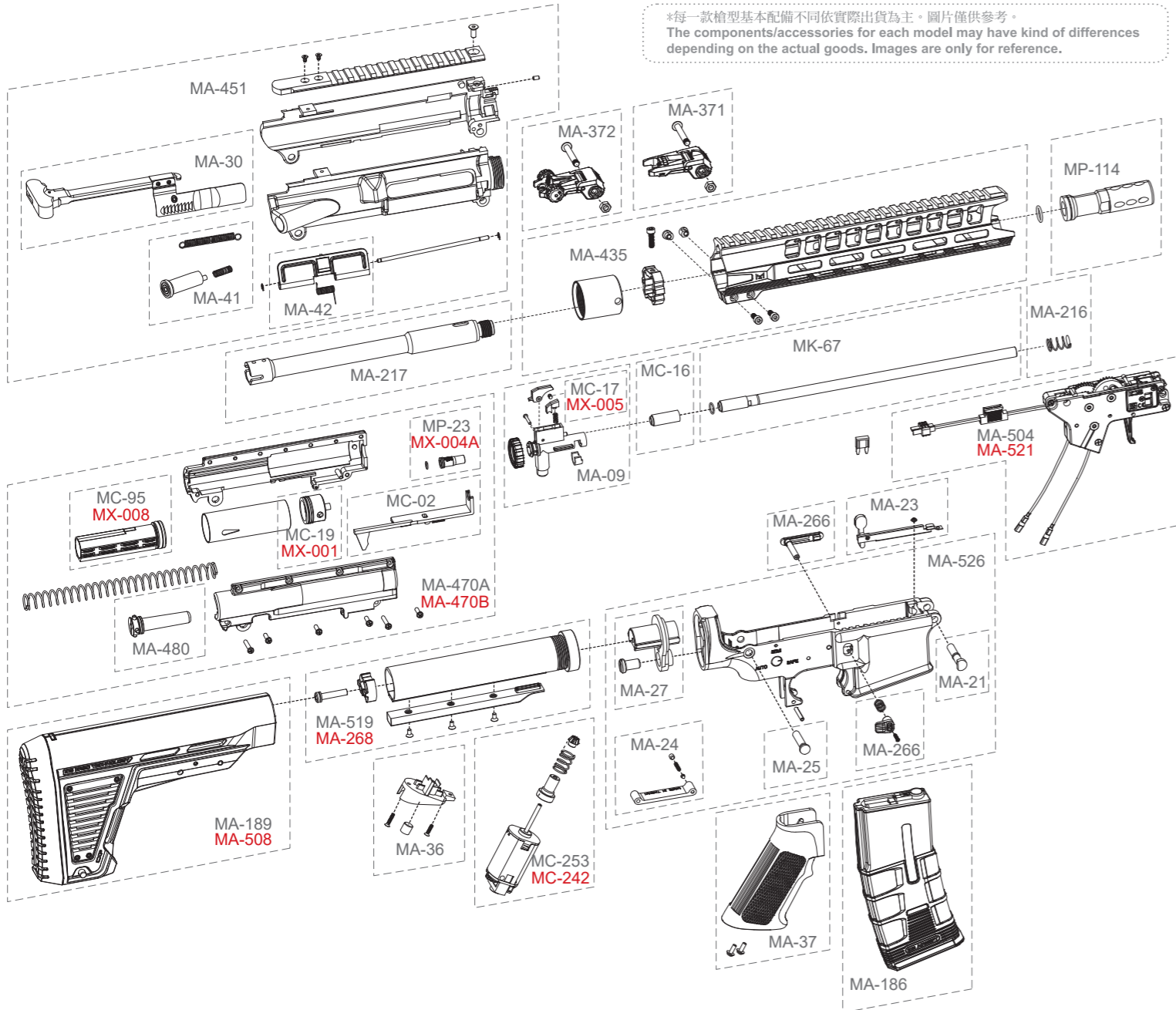

WARNING 警告 電槍使用之注意事項 Maintenance

- 請勿使用劣質或回收BB彈，以減少槍管損耗及避免卡彈。
 - 一旦發生卡彈或射擊速度降低時，應立即停止射擊，以避免齒輪過度耗損。請使用通槍條將殘彈清除，或檢測電池電量後方可繼續使用。
 - 不使用本產品時，請務必將射擊選擇鈕置於保險(S)的位置上，並將電池移除並定期使用通槍條清潔槍管。
 - 請依照原廠附贈之保險絲規格使用。不當配置可能導致零件故障，槍內配置M100彈簧請用20A保險絲，M120彈簧請用25A保險絲。
 - 彈頭直徑6mm。其槍口動能為二焦耳以下、射擊範圍為50公尺以內。
 - 適用年齡為十六歲以上，未成人使用時需有成年人在場監督。
 - 使用本商品不得改造或變造，並不得使用金屬彈頭。
 - 「此槍非玩具」，濫用可能造成嚴重傷害，尤其是眼睛。使用時應確保本身及射擊範圍內所有人員均已確實穿戴護目鏡。
 - 使用方法或注意事項請詳閱說明書內容。
- (原產地：台灣 / 製造商：一之軒企業有限公司 / 地址：台中市神岡區東洲路79巷67號 / 電話：04-25256461)



1 各部名稱 Series Component

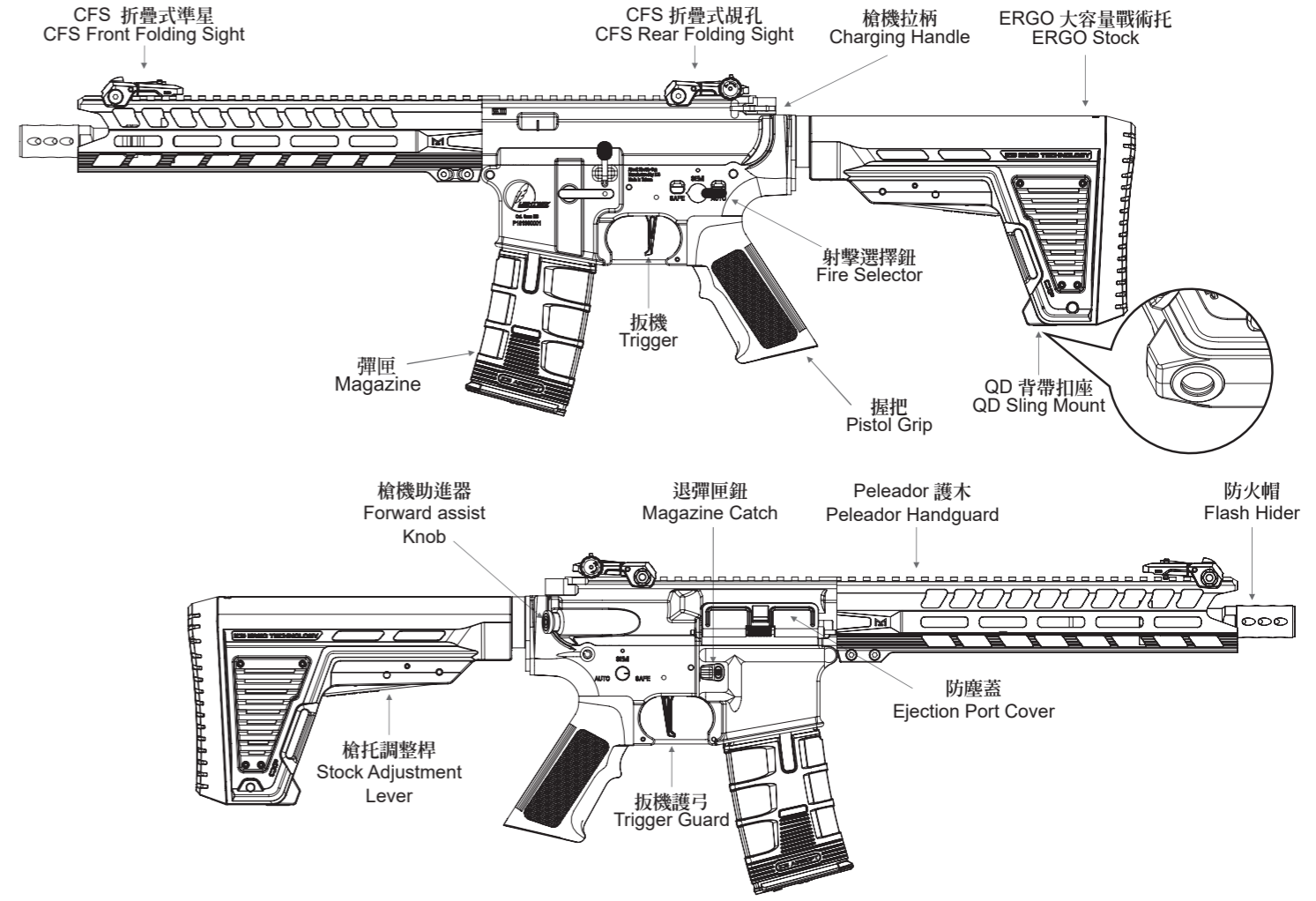

相關系列產品型號與詳細規格，請以官方網站公布為主。
For related series product models and detailed specifications, please refer to the official website.

2 彈匣使用方式 Magazine Attachment

2-1 裝BB彈方式 Load BBs

將彈匣上蓋依箭頭方向推開再倒入BB彈。
Open the cover to load BBs.

建議使用 6mm BB彈。
6mm caliber BBs are recommended for optimum performance.

依箭頭方向旋緊彈匣底下旋鈕，即可將BB彈順利送出。
To charge BB feed spring, please rotate the gear under the magazine.

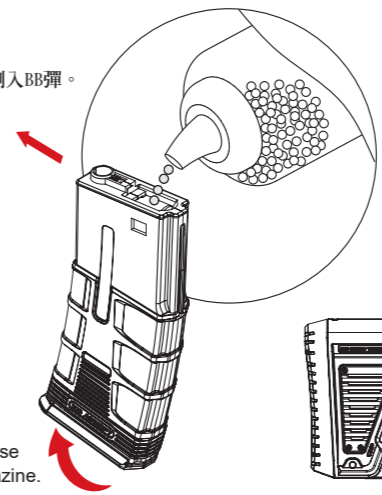

2-2 裝卸彈匣 Magazine Loading and Unloading

- 直接將彈匣插入彈匣插槽。
- 按壓退彈匣鈕即可將彈匣卸下。

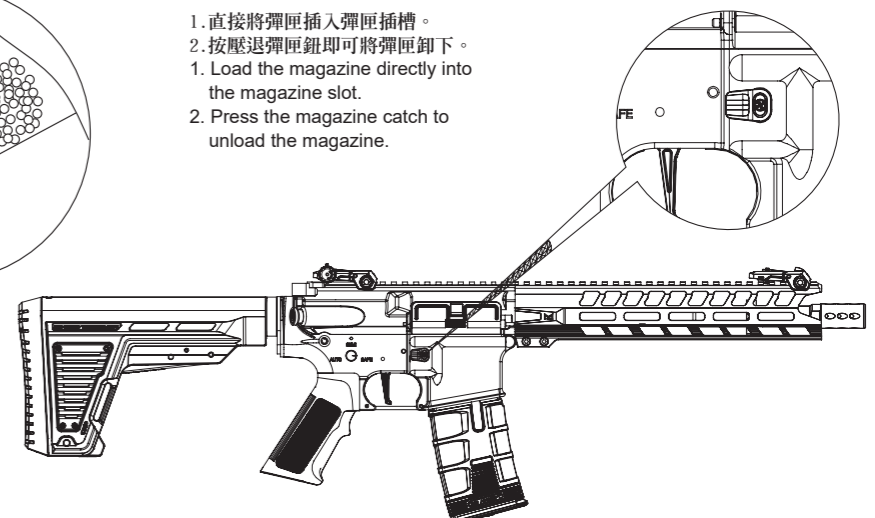

3 可動部的說明 Movable Parts

3-1 可做動作 Movable parts

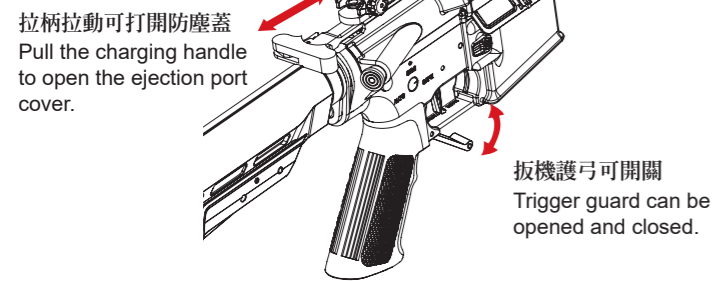

拉柄拉動可打開防塵蓋
Pull the charging handle to open the ejection port cover.

扳機護弓可開關
Trigger guard can be opened and closed.

※此系列產品具備「彈簧釋放功能」。

1. 槍枝上彈的情況下，按壓槍機助進器可釋放彈簧，再次擊發時有機率造成第一發雙彈射出或者小便彈，屬正常情況。
2. 槍支使用完畢後：
 - (1) 請轉至單發模式下，擊發2-3下後做清槍動作
 - (2) 關保險並確保槍管內已無殘彈
 - (3) 按壓槍機助進器釋放彈簧
3. 上下槍身分解前，務必先關保險並釋放彈簧，避免造成齒輪倒轉損壞活塞。

※釋放彈簧可延長彈簧壽命，避免長期擠壓造成疲乏。

※ This series has "spring release" function.

1. If the AEG is loaded with magazine, the spring can be released by pressing the forward assist knob, but also has chance to fire 2 BBs on your first shot or fire with low muzzle velocity, which are normal conditions.
2. Once you finished using your AEG:
 - (1) Please select your fire selector to semi-auto, clear your gun by firing 2 to 3 times.
 - (2) Engage the safety and make sure no BB pellets are remained in the barrel.
 - (3) Press the forward assist knob to release the spring.
3. Before you disassemble the upper and lower receiver, make sure you have engaged the safety and released the spring, to avoid gear reversal and cause damage to the piston.

※ Releasing the spring can extend its service life time, and avoid elastic fatigue caused by long-term extrusion.

4 精確射擊調整動作 Precision Targeting Adjustment

4-1 準星視孔調整方式 Front and Rear Sight Adjustment

A: 開合準星視孔 Rear and Front sights usage

準星視孔立起或收合皆可瞄準
You can aim with the Front and Rear sight either raised or folded.

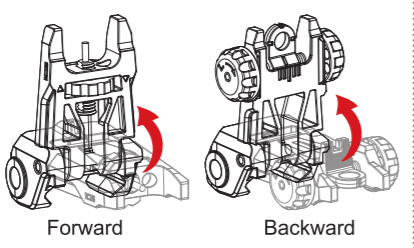

B: 視孔調整方式 Rear sight adjustment

依旋鈕方向旋轉即可將視孔組左右調整
Rotate clockwise to aim right.
Rotate counter clockwise to aim left.

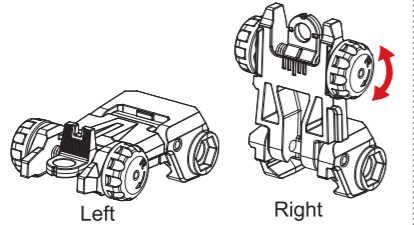

C: 準星高度調整 Front sight adjustment

將調整扭轉左即可升高準星；
將調整扭轉右即可降低準星。
Rotate the dial counterclockwise to raise the aiming point.
Rotate clockwise to lower the aiming point.

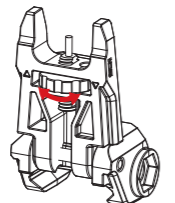

3-2 槍身結合3號齒正確位置圖 The correct position of sector gear before reassembling

注意 CAUTION 未進行歸位校正，會損壞活塞及齒輪
※ The piston and gear may be damaged without correcting the position in advance.

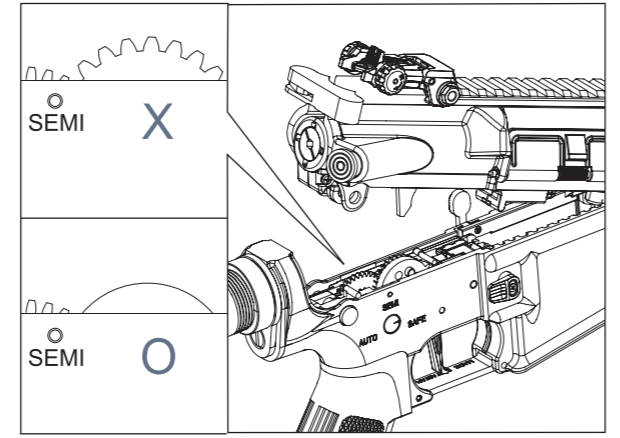

3號齒在槍身結合時，必須轉到正確位置，才可將上槍身蓋下。
Make sure the sector gear is turned to the correct position before reassembling the receiver/gearbox.

3-3 調整伸縮托長度 Adjust Retractable Stock Length

槍托調整桿往上推後，即可將伸縮托向後拉向前推，共有4-5段可供調整長度。
Press and hold the stock adjustment lever to unlock. Adjust the 4-5 position retractable stock to the most comfortable position.

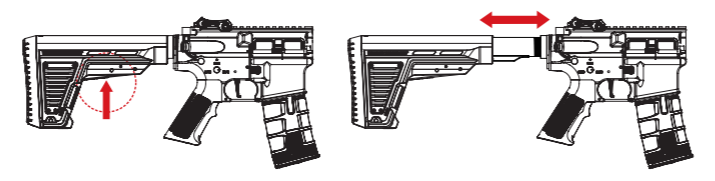

4-2 快拆尾頂桿 QD Spring Guide

1. 使用4mm六角板手，對準尾頂桿往內推入後旋轉45度
2. 將尾頂桿與彈簧抽出
※ 安裝彈簧後依照步驟1倒序組裝

1. Use 4mm Allen key, insert it to the spring guide and then press down to turn 45 degrees.
2. Take out the spring guide and spring.
※ Reverse the above steps to install spring.

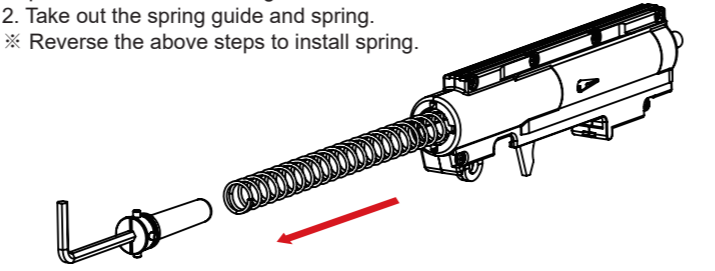

4-3 選擇射擊模式 Shooting Mode Setting

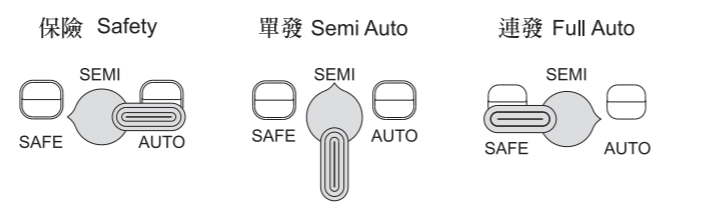

5 H-UP 彈道調整 H-UP Adjustment

注意 CAUTION 非必要時，手指請勿放置於H-UP調整處，避免受傷
※ To avoid injuries, only put your finger on the H-up adjustment when necessary.

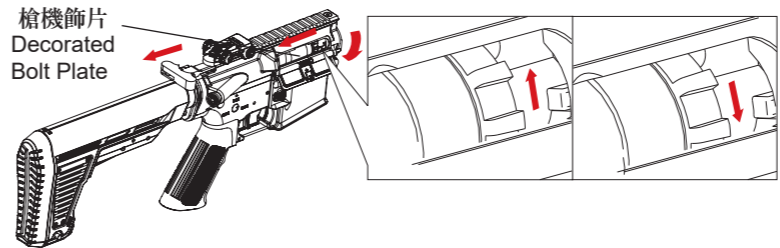

1. 將槍機拉柄往後拉(不可放開)，防塵蓋下翻、槍機飾片向後打開，即可進行彈道調整。
2. 視彈道進行撥盤調整，調整完即可放開槍機拉柄。

1. To adjust the trajectory, pull and hold the charging handle to the end (do not release) to open the ejection port cover downward, and open the decorated bolt plate backward.
2. Rotate the dial to adjust the trajectory. Release the charging handle once you finished the adjustment.

H-UP調整：BB彈呈現一直線的彈道才是正確射法。
過於上飄：將撥盤向上旋轉。
過於下墜：將撥盤向下旋轉。

H-up Adjustment: Make sure the trajectory of the BB pellets to be straight.
When the BB pellet flies up: Rotate the dial counter-clockwise to lower the trajectory.
When the BB pellet falls down: Rotate the dial clockwise to raise the trajectory.

6 電池及護木的拆裝方法 Disassembling for Battery and Handguard

注意 CAUTION 重新組裝時，必須依反方向做組合。
※ Reassembling is the reverse of disassembling procedures.

6-1 護木拆裝方式 Disassembling the handguard

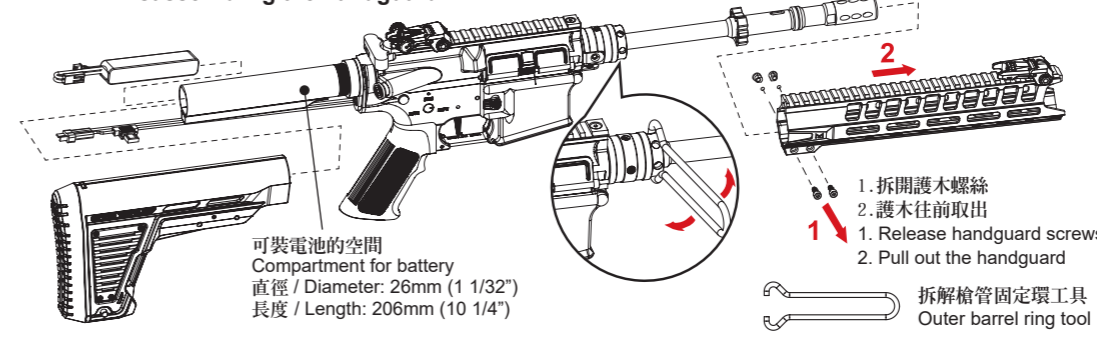

6-2 電池裝卸方式 Loading the battery

將槍托調整桿往下拉並轉向側邊，向後取下槍托，方便安裝電池。
Pull the stock adjustment lever downward and turn it to aside. The battery can be loaded with ease after you remove the stock backward.

拉開ERGO托蓋固定銷即可取下托蓋，方便安裝電池。
Pull the stock end plate pin out then remove the stock end plate to install the battery.

7 齒輪箱拆解 Disassemble Gearbox

注意 CAUTION 先卸彈匣跟電池，再進行拆解
※ Unload the magazine and battery before you proceed to disassemble.

