



AAKCMB46系列說明書 AAKCMB46 INSTRUCTION MANUAL

KWC KIEN WELL TOY INDUSTRIAL CO., LTD
www.kwcgun.com

台南市仁德區義林路168巷89號
NO.89, LN. 168, YILIN RD.,
RENDE DIST., TAINAN CITY
71752, TAIWAN (R.O.C.)
TEL : +886-6-2798175
FAX : +886-6-2798176
sales@kwcgun.com
www.kwcgun.com



操作/OPERATION

操作說明 / OPERATION

1. 取出彈匣 RELEASE MAGAZINE



- ▲注意: 請勿使彈匣直接掉落地面, 以防止變形或損壞。
- ▲ CAUTION: Magazine falling directly on the ground could cause deform or damage on it. Please be aware.

2. CO2小鋼瓶12g的使用 INSTALLING 12G CO2 CARTRIDGE

逆時針轉出彈匣底內件後, 置入小鋼瓶B, 再以順時針方向鎖緊彈匣底內件A。當刺破鋼瓶出氣時, 請快速鎖緊。

Turn the magazine cap out counter-clockwise and place CO2 cartridge B inside the magazine. Rapidly turn the screw A clockwise when piercing the cartridge in the magazine.

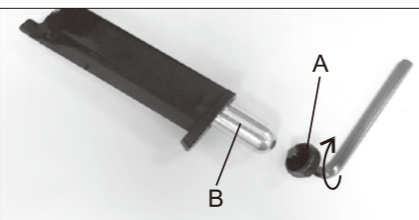

- ▲注意: 為維護彈匣使用壽命, 請盡可能不要殘留CO2氣體於彈匣內。
- ▲ CAUTION: To protect your magazine, please release all of the CO2 out of the magazine after every use.

3. 填裝B.B彈 LOADING BBS

彈匣最多可裝 16顆B.B彈, 如強行裝入更多, 可能造成不當損壞及無法上膛, 請注意。(分2種方式裝彈)

BB's max capacity is 16 rounds. If you load more than this quantity, you would bring any abnormal problems. (BB can be loaded in two ways.)

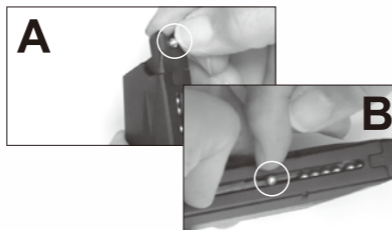

4. 彈匣上膛 INSERTING THE MAGAZINE

將裝好B.B彈的彈匣插入槍身往上推入, 直到彈匣卡榫發出“卡嗒”為止。

Insert fully loaded magazine in the airsoft until you hear the sound of “CLICK”.

5. B.B彈上膛 CHAMBERING THE BB

將上蓋往後拉到底, 放開上蓋則會自動回位, 同時亦將B.B彈送上膛完成射擊準備。Pull the slide all the way back, then release the slide to cock the pistol.



- ▲注意: 拉動上蓋時, 請勿將手指扣住扳機, 以免發生不當射擊, 造成危險。
- ▲ CAUTION : The gun is now cocked and will fire when the trigger is pulled. Be careful not to fire accidentally.

6. 保險切換 SWITCH SAFETY

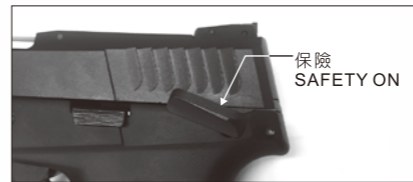
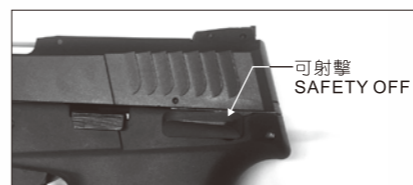

- ▲注意: 上蓋滑動時, 注意縫隙夾到手。
- ▲ CAUTION: This airsoft has a realistic blowback feature. Be careful of the pinch point.

7. 射擊 SHOOTING

對準目標區後扣下扳機, 則B.B彈將被射擊出去。Aim the target and pull the trigger. Then the BB will be shot.



- ▲注意: B.B彈用完時, 上蓋會後定卡住。
- ▲ CAUTION : hold open function as real pistol.

拆解 / DIS-ASSEMBLY

1. 按下卡榫, 取出彈匣。

Press the magazine catch to release the magazine.



2. 上膛。 Chambering



3. 按下上蓋卡定位件, 上蓋往前推。

Press both side of the slide locator at the same time and push the slide.



4. 上蓋組件往前推就可分離本體與上蓋。 The slide unit will separate from frame unit after pushed out front.



5. HOP UP 調整。 adjust HOP UP system.

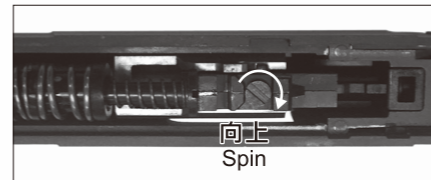

替換槍柄 / GRIP EXCHANGE

1. 將插銷取出 Pull out the pin between grip and magazine with tools.

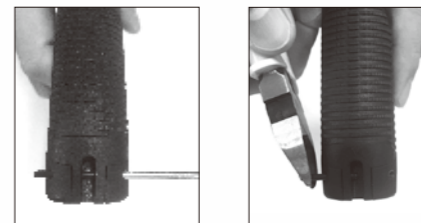

2. 槍柄握把向右拆除, 以替換其他握柄。 Take out the grip and change to other type.



故障的原因與排除 BREAK DOWN FAQ

* 卡彈可能原因:
the reason for BB jam :

- a. 裝彈排列不整齊
the BB in the magazine does not arrange very well.
- b. 不良B.B彈
bad quality BB
- c. 空擊發易造成零件損耗, 請避免此動作
Please avoid dry firing, for it could cause parts deformed or damage.

* 排除: 將上蓋往後拉, 向下倒出即可。
Solution : pull the slide back and pour the BB out from slide.

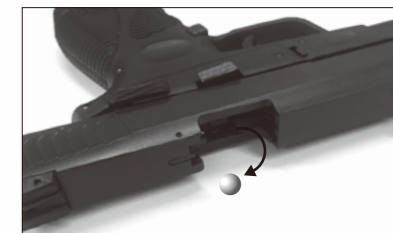

保養及維護 MAINTENANCE GUIDE

當射擊約2000發時, 建議你如圖所示, 以矽油脂適當在上蓋與本體滑動接觸面及擊鐵、撞針作動處潤滑, 以利滑動。

After every 2,000 BB shots, lubricating the Firing pin and Track as pictures below is recommended.

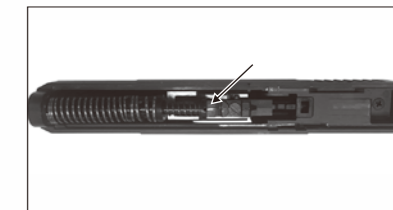

WARNING 警告

請務必嚴格遵守 使用說明指導書

For your safety, please read this manual carefully before use.

此低動能遊戲用槍是針對喜愛射擊運動的消費者所開發。避免因使用方法不正確或改造所發生的故障或事故，請務必詳讀說明書，正確的操作享受愉快的射擊運動。

- 除了發射時外，不要將手指頭掛在板機上。
- 選擇安全與適當標靶
- 在非使用期間，請保持保險關閉且退彈的狀態，就算在非使用狀態，也要如同其已裝彈。
- 如任何的機械產品，槍的保險也可能失效。即使在保險關閉的狀態下也請小心的操作此槍，請勿將槍口對人。
- 千萬不要對堅硬或平坦表面、水面射擊，以避免跳彈。
- 請妥善保管產品在未成年的孩童無法伸手取得的場所。
- 每次使用前後都應該檢查擋彈物，假如擋彈物表面有磨損失效或是反彈時請停止使用。
- 請使用高品質BB彈，請勿使用①口徑大於6mm②表面不平滑的③重複使用過的BB彈④非本說明書指名的發射物。
- 最高的使用及儲藏CO2小鋼瓶環境為50°C (122°F) 以內，高溫可能會造成CO2小鋼瓶過熱甚至爆炸。
- 檢查任何掉落之槍枝，以確保未影響其功能。

This airsoft is intended for recreational or training purposes. To prevent improper handling, modification or alteration causing malfunction or accident, please read the owner's manual carefully. Enjoy the pleasant shooting experience by proper operation.

- Do not put your finger on the trigger except shooting.
- Please choose safe and proper target.
- Please always keep the airsoft on safe and unloaded when not using.
- Like all mechanical devices, an airsoft safety can fail. Always handle the airsoft safely even when the safety is "on safe". Never point the airsoft at any people.
- Avoid ricochet. Never shoot at a hard or flat surface or at water.
- Keep the airsoft out of reach for small children.
- Your backstop should be inspected for wear before and after each use. Discontinue use of the backstop if surface shows signs of failure or ricochet.
- Only use high quality BB. Never use ①BB diameter larger than 6mm②BB with unsmoothed surface③reused BB that has been fired④incorrect projectiles not design for this airsoft
- Do not expose CO2 cartridges to heat or store them at temperatures above 50°C (122°F). CO2 cartridges may over heat or explode at temperatures above 50°C (122°F).
- Check any gun that has been dropped to ensure that its function has not been affected.

★使用低動能遊戲用槍前，請務必戴上保護眼鏡或面罩。

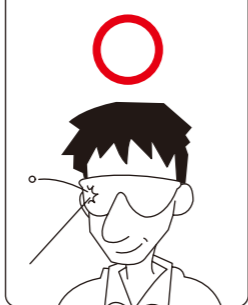

★不可攜帶低動能遊戲用槍在公共場所行走，請務必裝在袋子或盒子內。

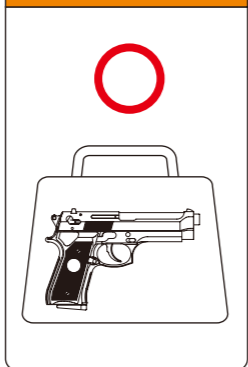

★使用低動能遊戲用槍前，請務必詳讀說明書內容。

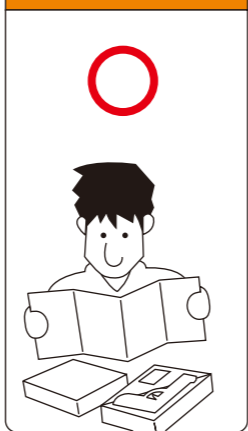

★請不要由槍口向內探視。



★請不要在公開場合使用低動能遊戲用槍，也請不要拿低動能遊戲用槍對準人或動物。

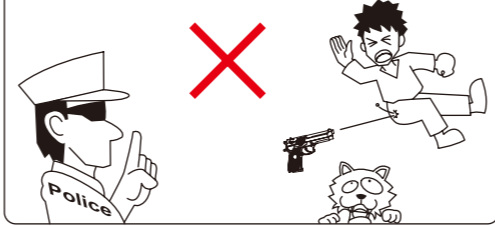

★請確認後再發射BB彈方向，附近無人或動物存在。

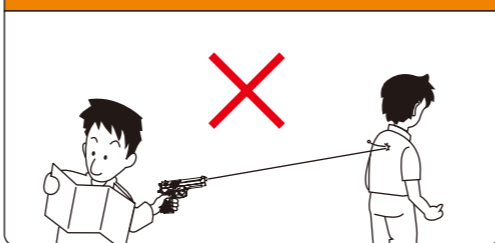

★不可任意改造或加工低動能遊戲用槍，私自改造加工會造成產品損壞、保固失效，導致使用上不安全，甚至觸法送辦。

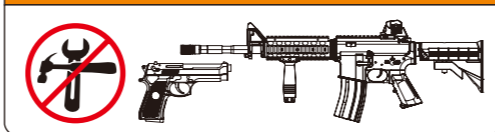

Do not display this pistol in public—it may confuse people and may be a crime. 請不要忘了，雖然自己知道這只是玩具，但不知道的人，會以為這是真槍。

AAKCMB46 系列 零件表 AAKCMB46 SERIES PARTS LIST

NO.	零件名稱	UNIT	NO.	零件名稱	UNIT	NO.	零件名稱	UNIT
P01	本體	FRAME	Z24	彈匣滑粒 4.5mm	MAGAZINE FOLLOWER	B30	氣缸配件軸	CYLINDER ACCESSORY PIN
P02	內槍管定位件4.5mm	INNER BARREL GUIDE	Z26	彈匣本體 4.5mm	MAGAZINE FRAME	KG12-B215	氣瓶頂針釘緊	PUNCTURE VAVLE PACKING
P03	內槍管配件4.5mm	INNER BARREL FITTING	Z27	擊鐵箱	CHASSIS	KCB22-L45	回位導桿螺絲	RECOIL BAR SCREW
P06	後準星	REAR SIGHT	Z28	槍身內套	FRAME BARREL BASE	S01	擊鐵卡榫扭簧	HAMMER CATCH SPRING
P07	後準星罩門	REAR SIGHT COVER	KC-22-Z28	鋼瓶鎖緊件	MAGAZINE BOTTOM CAP	SM1	彈匣壓簧4.5mm	MAGAZINE SPRING
KG15-P08	氣缸迫緊	CYLINDER PACKING	Z29	外槍管 4.5mm	OUTER BARREL	SM2	扳機扭簧	TRIGGER SPRING
P09	彈匣底座配件	MAGAZINE BASE ACCESSORY	Z30	氣缸配件	CYLINDER ACCESSORY	SM3	擊鐵扭簧	HAMMER SPRING
P10	扳機	TRIGGER	F01	上蓋止動片	SLIDE STOPPER	S03	上蓋止動片扭簧	SLIDE STOPPER SPRING
P11	扳機配件	TRIGGER ACCESSORY	KA27-F03	槍號	SERIAL NUMBER PLATE	S04	彈匣卡榫壓簧	MAGAZINE CATCH SPRING
P12	滑套射嘴	LOADING NOZZLE	R01	氣嘴迫緊	GAS ROUTE PACKING	S05	回位導桿緩衝簧	RECOIL BAR BUFFER SPRING
P14	彈匣上部 4.5mm	MAGAZINE RIB	KMB23-R01	子彈迫緊 4.5mm	RUBBER CHAMBER	S06	射嘴回位壓簧	LOADING NOZZLE RECOIL SPRING
P15	槍柄(S)	GRIP (S)	G008	O形環 1X6(氣閥用)	O-RING 1X6	S07	氣流控制件壓簧	FLOATING VALVE SPRING
P16	槍柄(M)	GRIP (M)	G016	O形環 PU S-4	O-RING PU S-4	S09	回位導桿緩衝簧	RECOIL BAR BUFFER SPRING
P17	槍柄(L)	GRIP (L)	G026	O形環 S12.5	O-RING S12.5	S10	撞針卡榫壓簧	FIRING PIN CATCH SPRING
P18	回位導桿外桿	RECOIL BAR OUTER SLEEVE	B02	槍身內套軸	PIN-FRAME BARREL BASE	S11	扳機連桿回位扭簧	TRIGGER BAR RECOVER SPRING
P19	回位導桿前配件	RECOIL BAR FRONT ACCESSORY	B03	回位導桿	RECOIL BAR	S12	撞針拉簧	FIRING PIN SPRING
P20	回位導桿墊片	RECOIL BAR GASKET	B04	彈匣卡榫軸	MAGAZINE CATCH PIN	S13	上蓋定位件壓簧	SLIDE LOCATOR SPRING
P21	氣流控制件4.5mm	FLOATING VALVE	B06	扳機配件軸	TRIGGER ACCESSORY PIN	S15	子彈迫緊調整螺絲壓簧	RUBBER CHAMBER ADJUST SCREW SPRING
KMB07-P41	心棒迫緊	VALVE PACKING	B07	擊鐵箱固定軸	CHASSIS SET PIN	S17	扳機配件壓簧	TRIGGER ACCESSORY SPRING
A01	上蓋	SLIDE	B08	擊鐵卡榫軸	HAMMER CATCH PIN	KG15-S20	心棒壓簧	VALVE SPRING
Z02	氣缸座	CYLINDER BASE	B09	上蓋定位件軸	SLIDE LOCATOR PIN	S21	導桿緩衝簧	RECOIL BAR BUMPER SPRING
Z03	保險(右)	SAFETY (R)	B11	後準星螺絲固定軸	REAR SIGHT SCREW SET PIN	S22	後準星固定軸壓簧	REAR SIGHT SET AXLE SPRING
Z04	保險(左)	SAFETY (L)	B12	後準星罩門螺絲	REAR SIGHT COVER SCREW	S23	保險定位壓簧	SAFETY LOCATOR SPRING
Z05	彈匣卡榫	MAGAZINE CATCH	B13	子彈迫緊調整螺絲	HOP UP ADJUST SCREW	S24	氣缸配件扭簧	CYLINDER ACCESSORY SPRING
Z06	彈匣卡榫配件	MAGAZINE CATCH ACCESSORY	B14	擊鐵軸套軸	HAMMER SLEEVE PIN	E06	2mm 鋼珠	2MM BEARING
Z07	保險止動件	SAFETY STOPPER	B15	回位導桿前端螺絲	RECOIL BAR FRONT SCREW	EA045	ΦM3.0X8 鍍鎳/鍍落處理	SCREW M3.0X8
Z08	槍管定位件(左)	BARREL LOCATOR (L)	B16	撞針拉簧軸	FIRING PIN SPRING AXLE	EA064	Φ中 2.3X6 束黑熱(槍管左右用)	SCREW 2.3X6
Z09	槍管定位件(右)	BARREL LOCATOR (R)	KCB48-B17	氣閥本體	VALVE FRAME	EA074	Φ中 M3X6 黑	SCREW M3X6
Z11	後準星螺絲調整軸	PIN-REAR SIGHT ADJUSTMENT SCREW	KCB48-B18	心棒後部	VALVE REAR	EA100	止付螺絲M2.5X6 黑(前準星用)	SET SCREW M2.5X6
Z12	子彈迫緊調整件	HOP-UP ADJUST PLATE	KCB48-B19	擊鐵軸套	HAMMER SLEEVE	EB002	彈簧墊圈	SPRING WASHER
Z13	擊鐵	HAMMER	B22	扳機軸套	TRIGGER SLEEVE	EF010	軸(擊鐵箱)	PIN(CHASSIS)
Z14	擊鐵卡榫	HAMMER CATCH	KCB48-B22	射嘴壓簧導軸	NOZZLE SPRING GUIDE PIN	X1	內槍管組件	INNER BARREL UNIT
Z15	撞針	FIRING PIN	B24	彈匣上部軸(短)	MAGAZINE RIB PIN(S)	X2	氣缸組件	CYLINDER UNIT
Z16	撞針卡榫	FIRING PIN CATCH	B25	彈匣上部軸(長)	MAGAZINE RIB PIN(L)	U1	扳機組件	TRIGGER UNIT
Z17	扳機連桿	TRIGGER BAR	KCB23-B26	氣瓶頂針	PUNCTURE VAVLE	U2	擊鐵組件	HAMMER UNIT
Z19	上蓋定位件	SLIDE LOCATOR	KCB48-B27	心棒	VALVE	U3	氣閥組件	VALVE UNIT
Z20	前準星	FRONT SIGHT	B27	內槍管4.5mm	INNER BARREL	U4	氣瓶頂針組件	PUNCTURE VAVLE UNIT
Z21	上蓋飾片	SLIDE COVER	B28	定位軸	LOCATOR PIN			
Z23	後準星螺絲	REAR SIGHT SCREW	B29	保險定位軸	SAFETY LOCATOR PIN			

AAKCMB46 系列 零件分解圖 AAKCMB46 SERIES EXPLODED VIEW

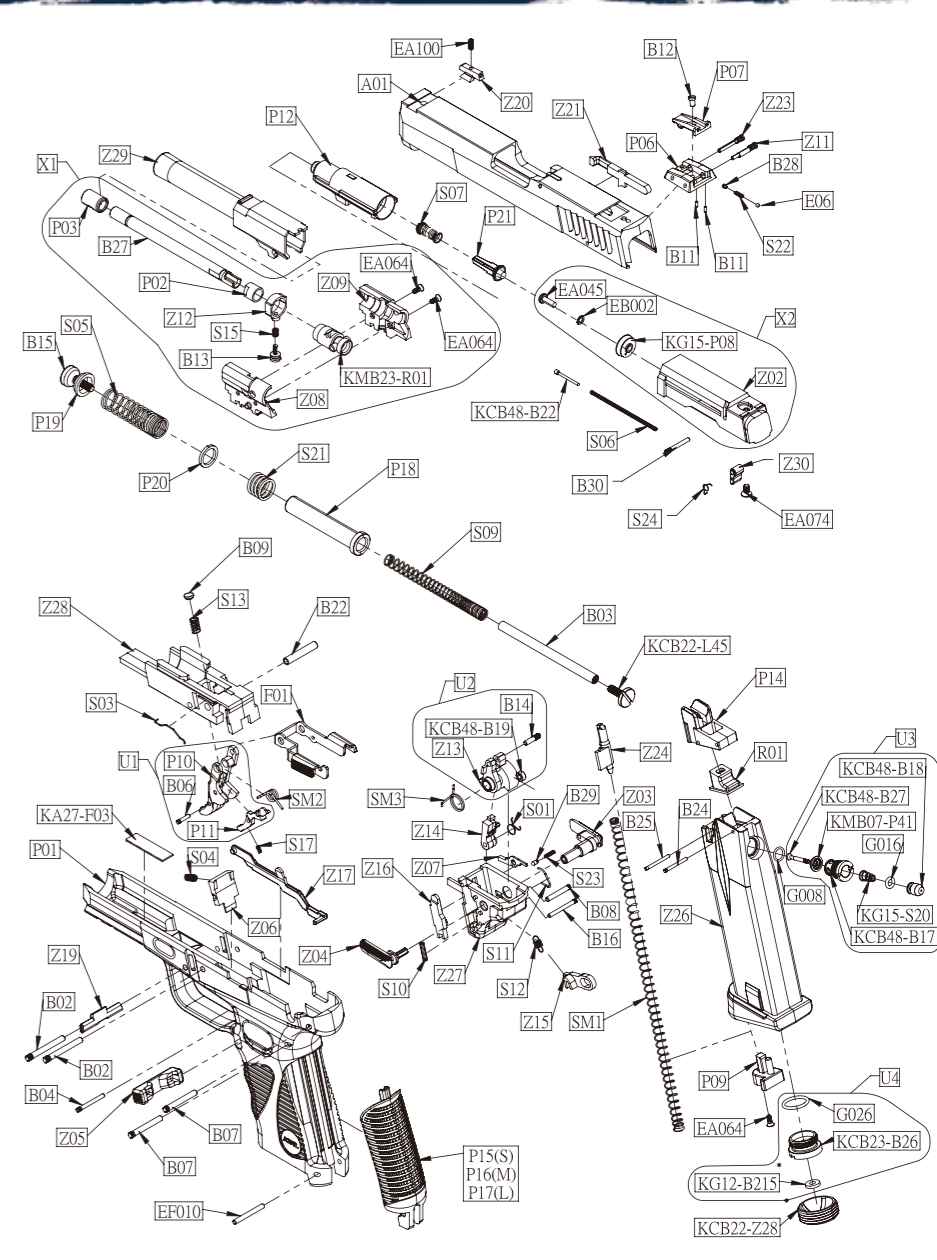

※零件有時為了改良而不經預告變更。
Spare parts may be modified for quality improvement
And such modification may be without advance notice.