

M712 Broomhandle



AAKCMF18 系說明書 AAKCMF18 INSTRUCTION MANUAL

KWC KWIEN WELL TOY INDUSTRIAL CO., LTD
www.kwcgun.com
台南市仁德區義林路168巷89號
NO.89, LN. 168, YILIN RD.,
RENDE DIST., TAINAN CITY
71752, TAIWAN (R.O.C.)
TEL : +886-6-2798175
FAX : +886-6-2798176
sales@kwcgun.com
www.kwcgun.com



操作/OPERATION

操作說明

OPERATION

1. 取出彈匣。
RELEASE MAGAZINE.



- ▲注意：請勿使彈匣直接掉落地面，以防止變形或損壞。
- ▲CAUTION: Magazine directly falling on ground could cause deform or damage on it. Please be aware.

2. CO2 鋼瓶的使用：
Installing CO2 Cartridge:
逆時針轉出旋塞後，置入小鋼瓶B，再以順時針方向鎖緊旋塞A。當刺破鋼瓶出氣時，請快速鎖緊。
Turn the magazine cap out counter-clockwise and place CO2 cartridge B inside the magazine. Rapidly turn the screw clockwise when piercing the cartridge in the magazine.

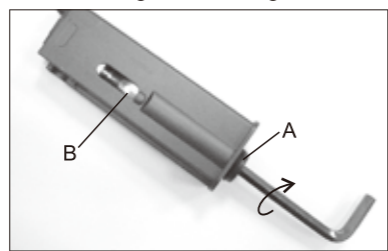

- ▲注意：為維護彈夾使用壽命，每次使用後請盡可能不要殘留CO2氣體於彈匣內。
- ▲CAUTION: To protect your magazine, please release all of the CO2 out of the magazine after every use.

3. 彈匣最多可裝19顆B.B彈，如強行裝入更多，可能造成不當損壞及無法上膛，請注意。
BB's max capacity is 19 rounds. Loading more than the capacity could cause some abnormal problems.

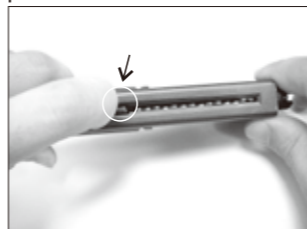

4. 彈匣上膛
INSERTING THE MAGAZINE
將裝好BB彈的彈匣插入槍身往上推入，直到彈匣卡筴發出"卡嗶"為止。
Put on the magazine with full of BBs until sound "CLICK".

5. B.B彈上膛
CHAMBERING THE BB
將槍機滑蓋往後拉到底，放開則會自動回位，同時亦將B.B彈送上膛完成射擊準備。

To load the BB in the pistol, pull the bolt to the end and release it.



- ▲注意：拉動上蓋時，請勿將手指扣住扳機，以免發生不當射擊，造成危險。
- ▲CAUTION: The gun is now cocked and will fire when the trigger is pulled. Be careful not to fire accidentally.

6. 保險切換
SWITCH SAFETY



7. 要關保險時請先拉槍機，才可關保險。
Safety only function when pistol is chambered.



8. 射擊
SHOOTING
對準目標區後扣下扳機，則B.B彈將被射擊出去。
Aim the target and pull the trigger, then BB will shot.



9. 單/連發設定
Semi / Full auto switch

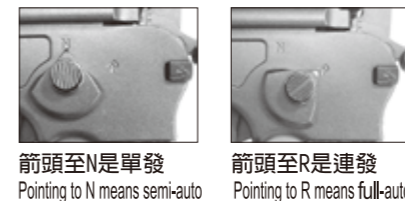

箭頭至N是單發
Pointing to N means semi-auto
箭頭至R是連發
Pointing to R means full-auto

10. 後準星調整
Rear sight adjustment



依個人喜好習慣，可將後準星調整至適當高度，以利射擊。
Adjustable rear sight

拆解/DISASSEMBLY

1. 先退下彈匣
Eject the magazine first.



2. 於擊鐵後端將定位件往上推
Push up the guide behind the hammer.

3. 按住後往右移，就可分離拆卸上蓋和本體。
Press and hold, slide to right side to disassemble slide from frame.

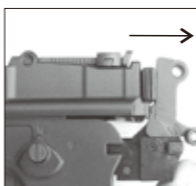

故障/BREAK DOWN



分離完成
Disassembly complete.

故障的原因與排除 BREAK DOWN FAQ

- * 卡彈可能原因：
the reason for BB jam :
- a. 裝彈排列不整齊
the BB in the magazine does not arrange very well.
- b. 不良B.B彈
bad quality BB
- c. 空擊發易造成零件損耗，請避免此動作。
Please avoid dry firing, for it could cause parts deformed or damage.

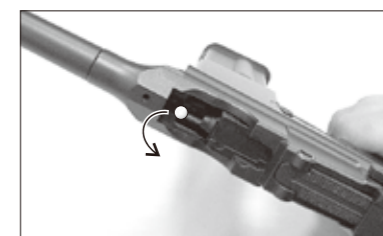

A: 排除：將上蓋往後拉，向下倒出即可。
Overcome : pull the slide back and pour the BB out from slide.

保養及維護 MAINTENANCE GUIDE

當射擊約2000發時，建議你如圖所示，以矽油脂適量在上蓋與本體滑動接觸面及擊鐵、撞針作動處潤滑，以利滑動。

After every 2,000 BB shots, lubricating the Firing pin and Track as pictures below is recommended.

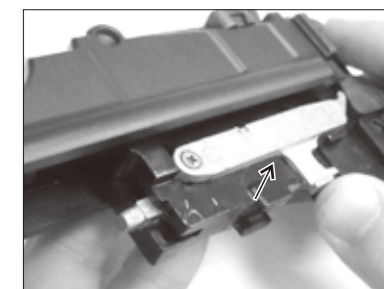
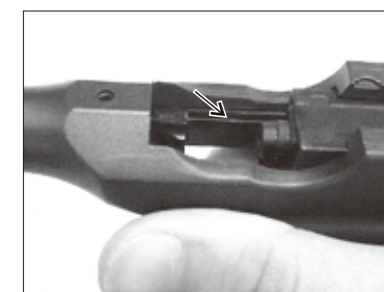
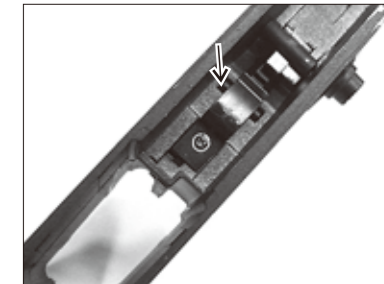
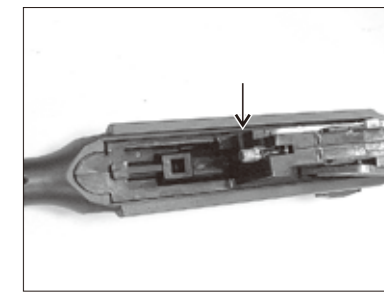

WARNING 警告

請務必嚴格遵守 使用說明指導書

For your safety, please read this manual carefully before use.

此低動能遊戲用槍是針對喜愛射擊運動的消費者所開發。避免因使用方法不正確或改造所發生的故障或事故，請務必詳讀說明書，正確的操作享受愉快的射擊運動。

- 除了發射時外，不要將手指頭掛在板機上。
- 選擇安全與適當標靶
- 在非使用期間，請保持保險關閉且退彈的狀態，就算在非使用狀態，也要如同其已裝彈。
- 如任何的機械產品，槍的保險也可能失效。即使在保險關閉的狀態下也請小心的操作此槍，請勿將槍口對人。
- 千萬不要對堅硬或平坦表面、水面射擊，以避免跳彈。
- 請妥善保管產品在未成年孩童無法伸手取得的場所。
- 每次使用前後都應該檢查擋彈物，假如擋彈物表面有磨損失效或是反彈時請停止使用。
- 請使用高品質BB彈，請勿使用①口徑大於4.4mm②表面不平滑的③重複使用過的BB彈④非本說明書指名的發射物。
- 最高的使用及儲藏CO2小鋼瓶環境為50°C(122°F)以內，高溫可能會造成CO2小鋼瓶過熱甚至爆炸。
- 檢查任何掉落之槍枝，以確保未影響其功能。

This airgun is intended for recreational or training purposes. To prevent improper handling, modification or alteration causing malfunction or accident, please read the owner's manual carefully. Enjoy the pleasant shooting experience by proper operation.

- Do not put your finger on the trigger except shooting.
- Please choose safe and proper target.
- Please always keep the airgun on safe and unloaded when not using.
- Like all mechanical devices, an airgun safety can fail. Always handle the airgun safely even when the safety is "on safe". Never point the airgun at any people.
- Avoid ricochet. Never shoot at a hard or flat surface or at water.
- Keep the airgun out of reach for small children.
- Your backstop should be inspected for wear before and after each use. Discontinue use of the backstop if surface shows signs of failure or ricochet.
- Only use high quality 4.5mm steel BBs. Never use ①BB diameter larger than 4.4 mm②BB with unsmoothed surface③reused BB that has been fired④incorrect projectiles not design for this airgun
- Do not expose CO2 cartridges to heat or store them at temperatures above 50°C(122°F). CO2 cartridges may over heat or explode at temperatures above 50°C(122°F).
- Check any gun that has been dropped to ensure that its function has not been affected.

★使用低動能遊戲用槍前，請務必戴上保護眼鏡或面罩。

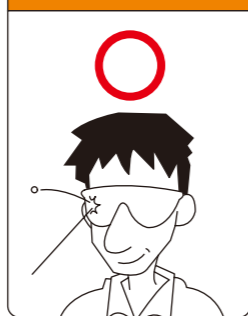

★不可攜帶低動能遊戲用槍在公共場所行走，請務必裝在袋子或盒子內。

★Always transport an airgun in a locked carrying case. Make sure it is unloaded and on safe.

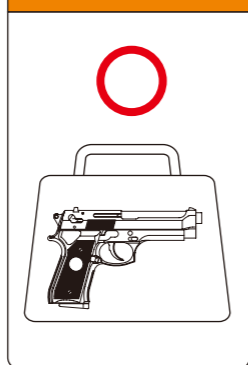

★使用低動能遊戲用槍前，請務必詳讀說明書內容。



★請不要由槍口向內探視。



★請不要在公開場合使用低動能遊戲用槍，也請不要拿低動能遊戲用槍對準人或動物。

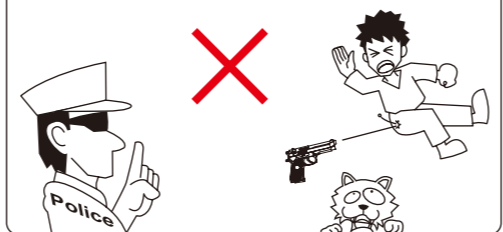

★請確認後再發射BB彈方向，附近無人或動物存在。



★不可任意改造或加工低動能遊戲用槍，私自改造加工會造成產品損壞、保固失效，導致使用上不安全，甚至觸法送辦。

★Disassemble, modify, or alter of your airgun may cause malfunction, void your warranty and may make it unsafe to use.

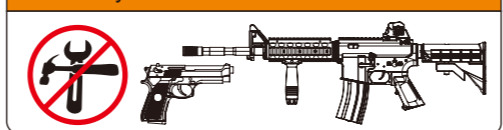

Do not display this pistol in public—it may confuse people and may be a crime. 請不要忘了，雖然自己知道這只是玩具，但不知道的人，會以為這是真槍。

KMB-18 系列 零件表 KMB-18 SERIES PARTS LIST

NO.	零件名稱	UNIT	NO.	零件名稱	UNIT	NO.	零件名稱	UNIT
P01	彈匣底內件(前部)	Magazine Base (Front)	Z32	單連發切換件	Switch	S09	單連發切換件壓簧	Switch Spring
P06	槍柄左	Grip L	Z33	單連發切換鈕	Switch Button	S10	擊鐵壓簧	Hammer spring
P07	槍柄右	Grip R				S11	撞針前部拉簧	Front Firing Hammer Spring
P12	槍管固定件	Barrel Catch	R01	氣嘴迫緊	Gas route	S12	滑套射嘴拉簧	Floating Nozzle Spring
P13	彈匣上部	Magazine Rib	R03	KMB41子彈迫緊(4.38)	Rubber chamber(4.38)	S13	擊鐵卡筭扭簧	Hammer catch spring
P14	氣流控制件(無肋)	Floating Valve (no Rib)	R04	氣缸迫緊	Breech packing	S14	擊鐵箱定位扭簧	Hammer Case Guide Spring
P19	滑套射嘴	Loading Nozzle	R05	O形環2X13	O-ring	S15	連發卡筭扭簧	Sear Spring
P41	心棒迫緊	Valve packing	R06	O形環1X6	O-ring	S17	撞針壓簧	Firing Hammer Spring
P60	彈匣底內件	Magazine cap	R07	O形環 PU S-4(黃)	O-ring	S18	汽缸緩衝壓簧	Breech Buffer Spring
						S20	心棒壓簧	VALAVE SPRING
Z01	槍身上部	Upper Frame	F01	鈹機彈片	Trigger Plate	S21	氣流控制件壓簧	Floating valve spring
Z02	槍身下部	Lower Frame	F03	汽缸壓簧定位片	Breech Spring Guide Plate	S22	彈匣壓簧	Magazine spring
Z03	外槍管	Outer barrel						
Z05	彈匣卡筭	Magazine catch	B02	滑套射嘴軸	Loading Nozzle Pin	E01	氣缸緩衝內六角螺絲*牙距*0.8	Screw
Z06	擊鐵箱右	CHASSIS RIGHT	B03	擊鐵壓簧軸	Hammer Spring Pin	E02	Φ3 2.6x7xP=0.45鍍鉻	Screw
Z07	擊鐵箱左	CHASSIS LEFT	B04	後準星軸	Rear Sight Pin	E03	彈簧銷 1.5x7L黑	Screw
Z08	汽缸座	Breech Base	B05	撞針前部軸	Front Firing Hammer Pin	E04	Φ 1/2*4尖附華司螺絲(熟)	Screw
Z10	滑套射嘴內件	Breech	B07	撞針軸	Firing pin axis	E05	Φ3 2.3x6束黑熟	Screw
Z12	汽缸壓簧定位件	Breech Spring Guide	B08	彈匣上部軸	Magazine rib pin	E08	Φ3 2.3x5束黑熟	Screw
Z13	後準星	Rear sight	B11	槍柄螺絲	Grip screw	E09	內六角止付螺絲3x3L*P0.5 黑	Screw
Z14	後準星高度調整件	Rear Sight Adjust Case	B12	槍柄螺帽	Grip Nut			
Z15	後準星高度調整件按鈕	Rear Sight Adjust Piece	B13	汽缸壓簧墊圈	Breech Spring Buffer	U3	氣閥組件	Valve unit
Z16	擊鐵箱定位件	Hammer Case Guide	B17	氣閥本體	Valve	U4	氣瓶頂針組件	Inner valve
Z17	鈹機	Trigger	B18	心棒後部	Rear valve			
Z18	鈹機配件	Trigger (Rear)	B20	內槍管	Compensator joint			
Z19	擊鐵卡筭	Hammer catch	B31	(固定)氣瓶頂針M16	(Fixed) Cartridge Stab M16			
Z20	撞針卡筭	Firing pin catch	B33	心棒	Rear valve			
Z21	擊鐵	Hammer	B215	氣瓶頂針迫緊(TFL)	Cartridge valve packing			
Z22	撞針	Firing pin						
Z23	撞針前部	Front Firing Hammer	S01	槍身下部扣環	Lower Frame Metal Ring			
Z24	保險	Safety	S02	氣缸座壓簧	Breech Base Spring			
Z25	連發卡筭	FULL AUTO CATCH	S03	彈匣卡筭壓簧	Magazine catch spring			
Z27	槍管定位件右	Barrel lock lever (R)	S04	後準星壓簧	Rear sight spring			
Z28	槍管定位件左	Barrel lock lever (L)	S05	後準星高度調整件壓簧	Rear Sight Adjust Case Spring			
Z29	彈匣	Magazine	S06	保險壓簧	SAFETY SPRING			
Z30	彈匣滑粒-4.5	Magazine Follower-4.5	S07	鈹機配件壓簧	Trigger (Rear) Spring			
Z31	擊鐵卡筭連動件	Hammer catch connector	S08	撞針卡筭壓簧	Firing pin catch spring			

KMB-18 系列 零件分解圖 KMB-18 SERIES EXPLODED VIEW

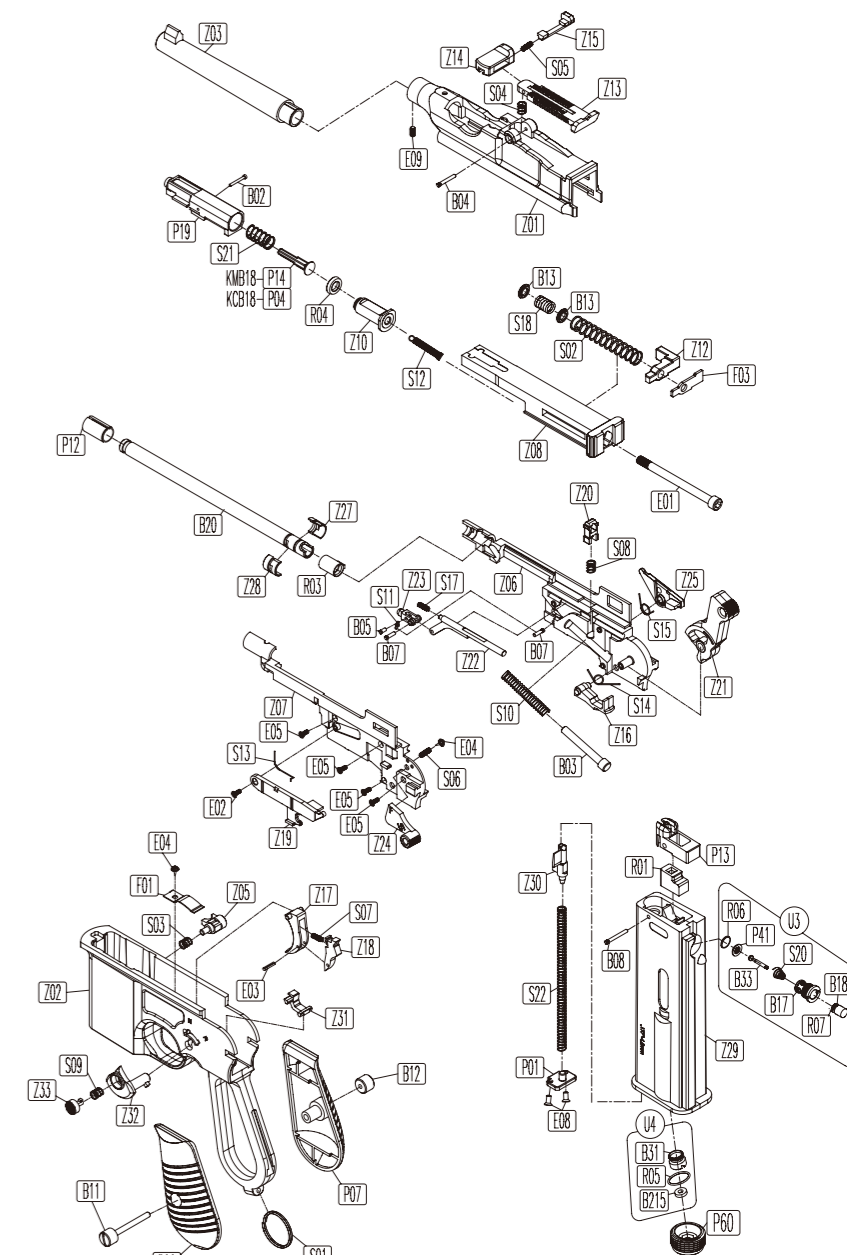

※零件有時為了改良而不經預告變更。
Spare parts may be modified for quality improvement
And such modification may be without advance notice.