

WARNING: BEFORE USAGE, THE INSTRUCTION MUSE BE READ.

THANK YOU FOR PURCHASING. THE FOLLOWING ATTENTION POINTS AND INSTRUCTIONS MUST BE READ. SHOOTING WITHOUT CAUTION OR USED IMPROPERLY, BLINDNESS OR INJURIES COULD BE LEAD.

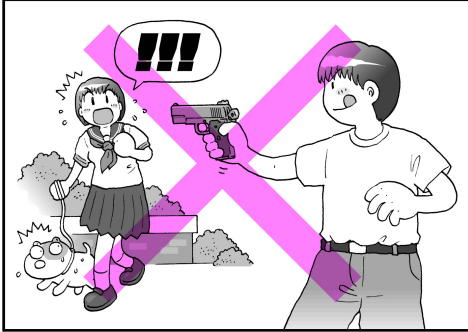

DO NOT POINT AT PEOPLE OR ANIMAL.



GUN AND GAS MUST NOT BE PLACED IN AREA WHERE TEMPERATURE IS OVER 40 °C

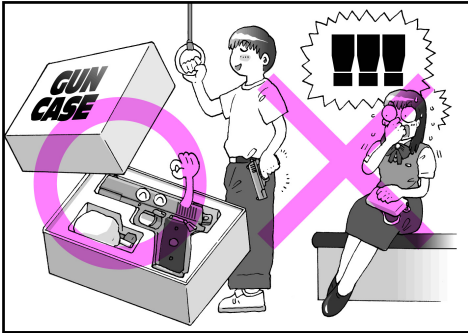

PLACE IN GUN CASE WHEN NOT IN USING OR TRANSPORTING



DO NOT USE GAS WHICH PRESSURE IS OVER 12 Kgs/cm²

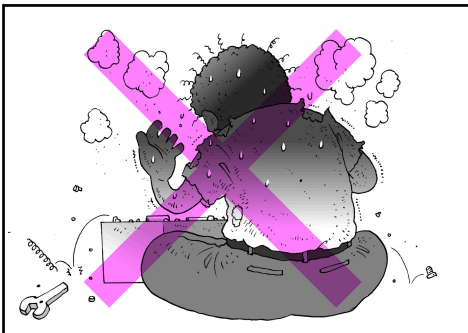

UNAUTHORIZED RECONSTRUCTION OF AIR SOFT GUN TO STRENGTHEN FIRING FUNCTION IS STRICTLY PROHIBITED.

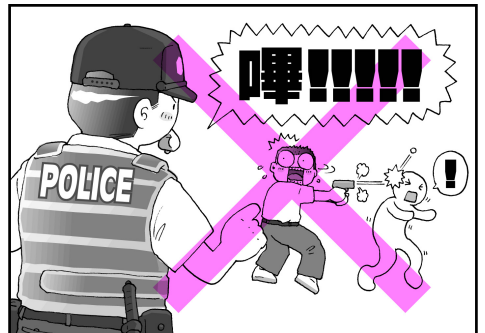

BE CAREFULL WHAT TARGET YOU SHOOT



EYE PROTECTION DEVICE MUST BE EQUIPPED



DO NOT LOAD ANYTHING BUT BB BULLETS.

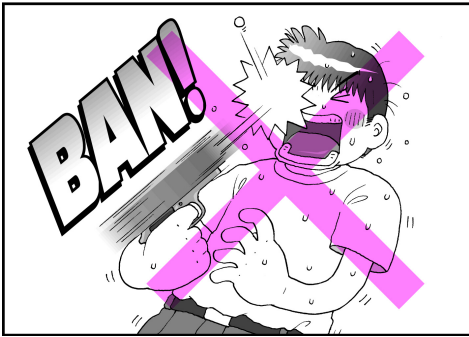

DO NOT LOOK THROUGH THE BARREL



PLEASE SHOOT IN SAFE PLACE

OPERATION

1.REMOVE THE MAGAZINE



PRESS MAGAZINE CATCH AND REMOVE MAGAZINE

2.FILLING GAS

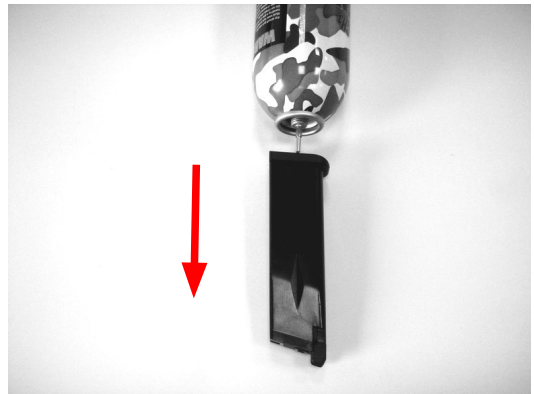

FILL THE GAS BOTTLE TO THE MAGAZINE IN VERTICAL DIRECTION.

3.LOAD BB BULLETS



LOAD BULLETS

4.INSERT MAGAZINE



5.LOAD



PULL THE SLIDE COMPLETELY TO THE REAR.

6.FIRE



PULL THE TRIGGER.

7.SAFETY

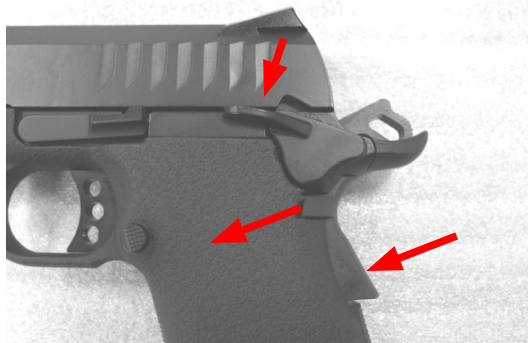

SAFETY OFF(READY FOR FIRE)

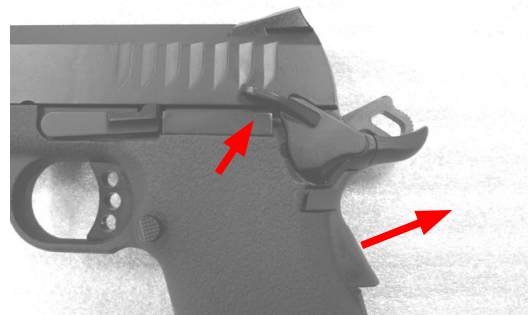

SAFETY ON

DISASSEMBLY

1.REMOVE THE SLIDE STOP

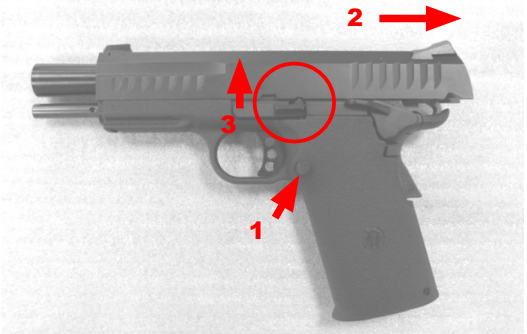

PRESS MAGAZINE CATCH AND REMOVE MAGAZINE.MOVE THE SLIDE REAR UNTIL THE TAKEDOWN NOTCH IS JUST ABOVE THE SLIDE STOP TAB AND REMOVE SLIDE STOP

2.REMOVE THE SLIDE



3.REMOVE THE RECOIL SPRING AND SPRING CAP

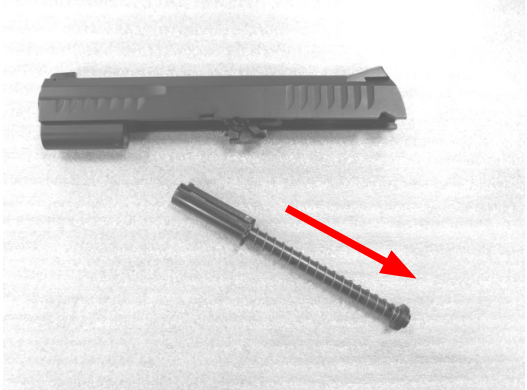

4.REMOVE THE BARREL

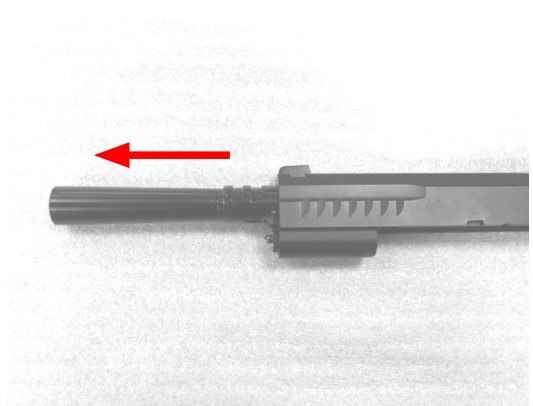

ASSEMBLY

REVERSE THE DISASSEMBLY ORDER

ADJUST TREJECTORY

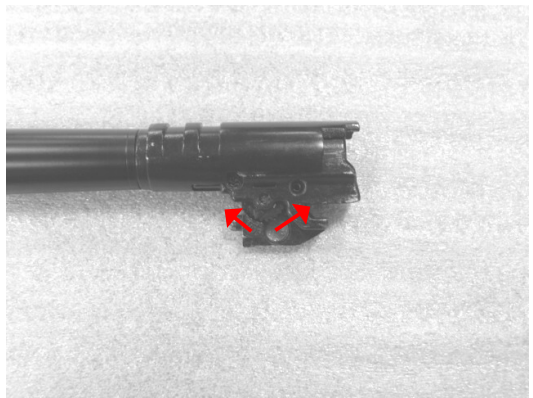

TWIST THE ADJUST DIAL TO ADJUST TEAJECTORY.

PLEASE ADJUST ACCORDING TO TREJECTORT

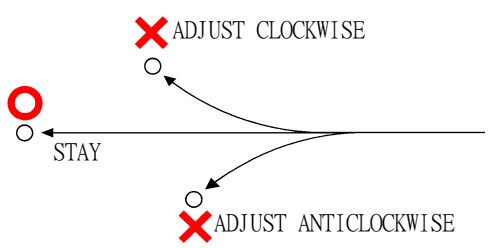

KP-08 EXPLODED DRAWING

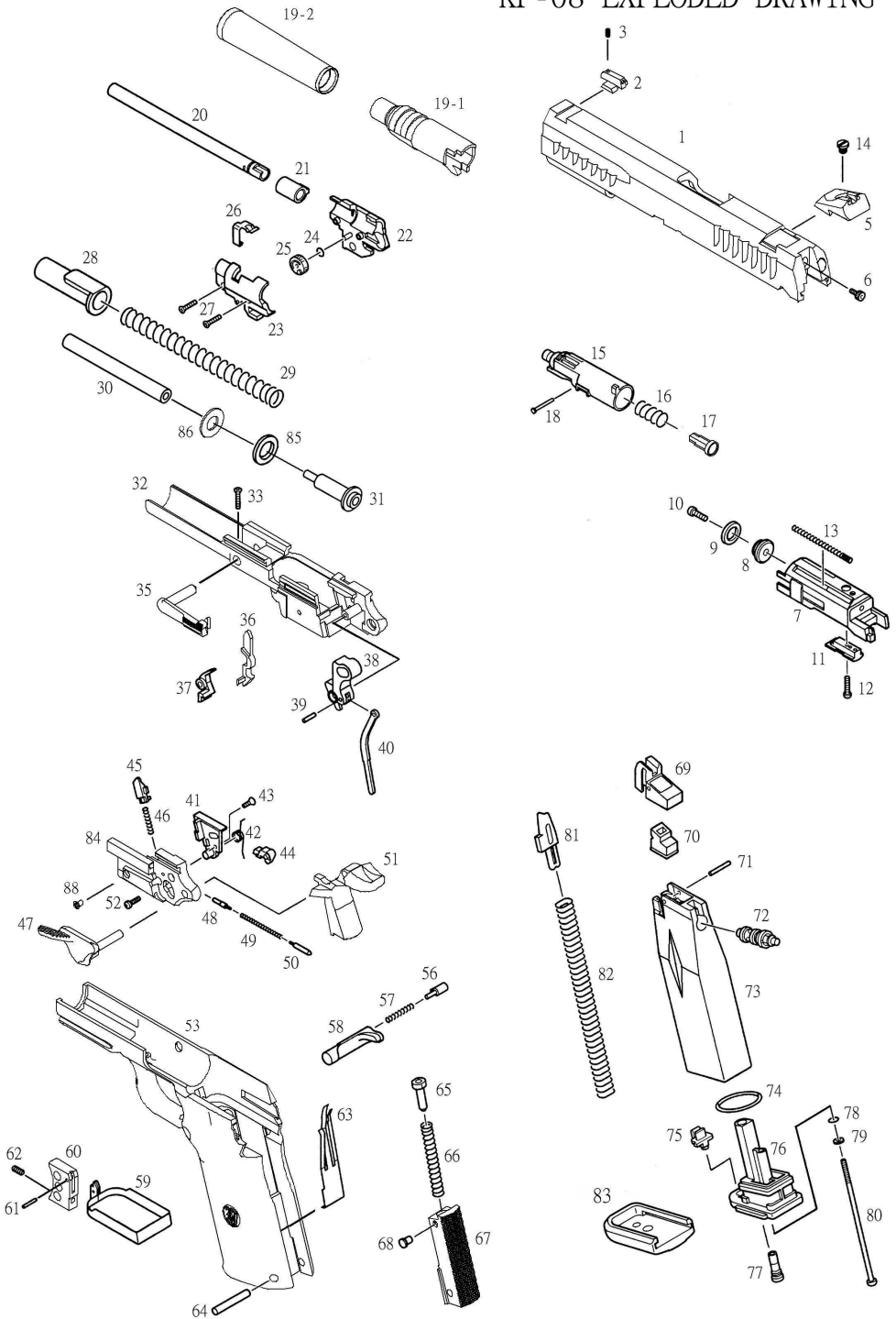

No.	Name of Part	Price	No.	Name of Part	Price
1	Slide	1600	48	Slide Stop Plunger	50
2	Front Sight	120	49	Slide Stop Plunger Spring	15
3	Front Sight Screw	10	50	Safety Plunger	50
5	Rear Sight	150	51	Grip Safety	240
6	Pinton Screw	20	52	Chassis Cover Screw	10
7	Piston	400	53	Grip	800
8	Ring Head	40	56	Magazine Catch Lock	30
9	Ring	20	57	Magazine Catch Spring	10
10	Ring Head Screw	10	58	Magazine Catch	120
11	Piston Part	30	59	Trigger Bar	150
12	Piston Part Screw	10	60	Trigger	240
13	Cylinder Return Spring	20	61	Trigger Pin	10
14	Rear Sight Screw	20	62	Trigger adjust Screw	20
15	Cylinder	150	63	Sear Spring	100
16	Cylinder Valve Spring	20	64	Housing Pin	50
17	Cylinder Valve	20	65	Hammer Spring Plunger	30
18	Cylinder Valve Stopper	20	66	Hammer Spring	70
19-1	Outter Barrel Part-1	300	67	Hammer Spring Housing	120
19-2	Outter Barrel Part-2	300	68	Plunger Stopper	40
20	Inner Barrel	180	69	BB Lip Pin	60
21	Rubber Chamber	80	70	Magazine Gasket	80
22	Chamber Cover (Right)	140	71	BB Lip Pin	10
23	Chamber Cover (Left)	140	72	Valve	150
24	O-Ring	10	73	Magazine Case	400
25	Adjust Dial	20	74	O-Ring	20
26	Adjust Lever	50	75	Magazine spring Retainer	20
27	Chamber Cover Screw	10	76	Magazine Base	180
28	Recoil Plug	200	77	Filling Valve	70
29	Recoil Spring	60	78	O-Ring	10
30	Recoil Spring Guide A	100	79	Washer	10
31	Recoil Spring Guide B	150	80	Magazine Base Screw	20
32	Chassis	600	81	Follower	30
33	Chassis Screw	10	82	Follower Spring	50
35	Slide Stop	200	83	Magazine Bottom	120
36	Disconnecter	150	84	Chassis Cover	200
37	Sear	120	85	Recoil Spring Guide Buffer	30
38	Hammer	300	86	Washer	20
39	Hammer Pin	10	88	Chassis Cover Screw	10
40	Hammer Strut	50			
41	Chassis Cover Part	80			
42	Knocker Spring	30			
43	Chassis Cover Part Screw	10			
44	Knocker	40			
45	Knocker Lock	50			
46	Knocker Lock Spring	20			
47	Safety (Left)	150			



KP-08 MANUAL

KJWORKS

kjworks.com.tw